

# Operation Manual

# **HYPROP 2**

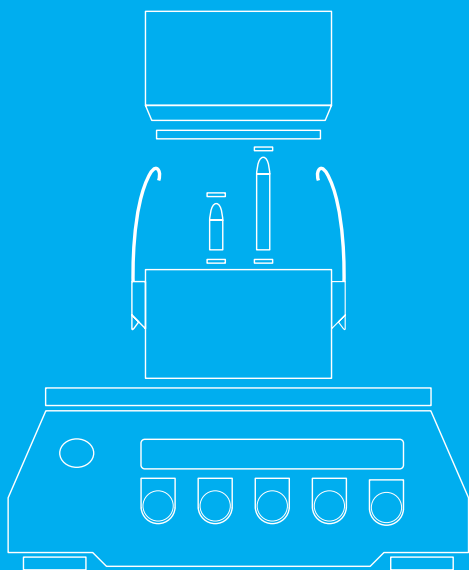

**METER**

# At a glance – how it works

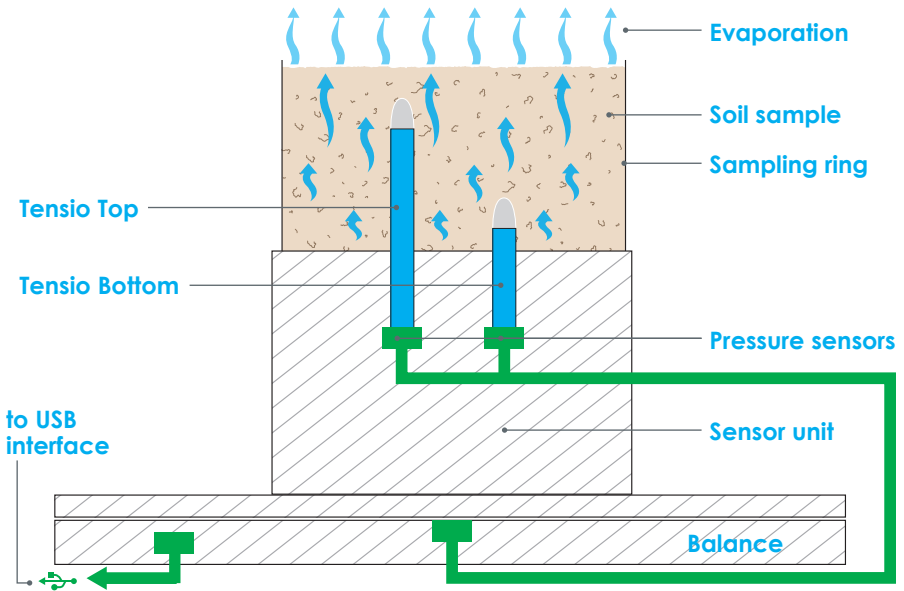

## Legend

water	electronics	soil	
water vapor	ceramic	all other parts	cross section of a part

HYPROP 2 is a fully automated measuring and evaluation system based on Schindlers evaporation method (1980) to determine the hydraulic properties of soil samples. With tensiometers in two depths the device measures the soil water tension as well as the unsaturated hydraulic conductivity. Additionally the volumetric water content is calculated through a continuous recording of weight loss.

With these information the water retention curve can be illustrated.

In comparison to HYPROP, HYPROP 2 convinces through, easier and more flexible handling and more robust and precise pressure transducers. Furthermore, a faster optical monitoring of the measurement is enabled through a LED ring visualizing the current status of the device.

Please find further information in the chapter "Theory".

# Parts of the device and scope of delivery

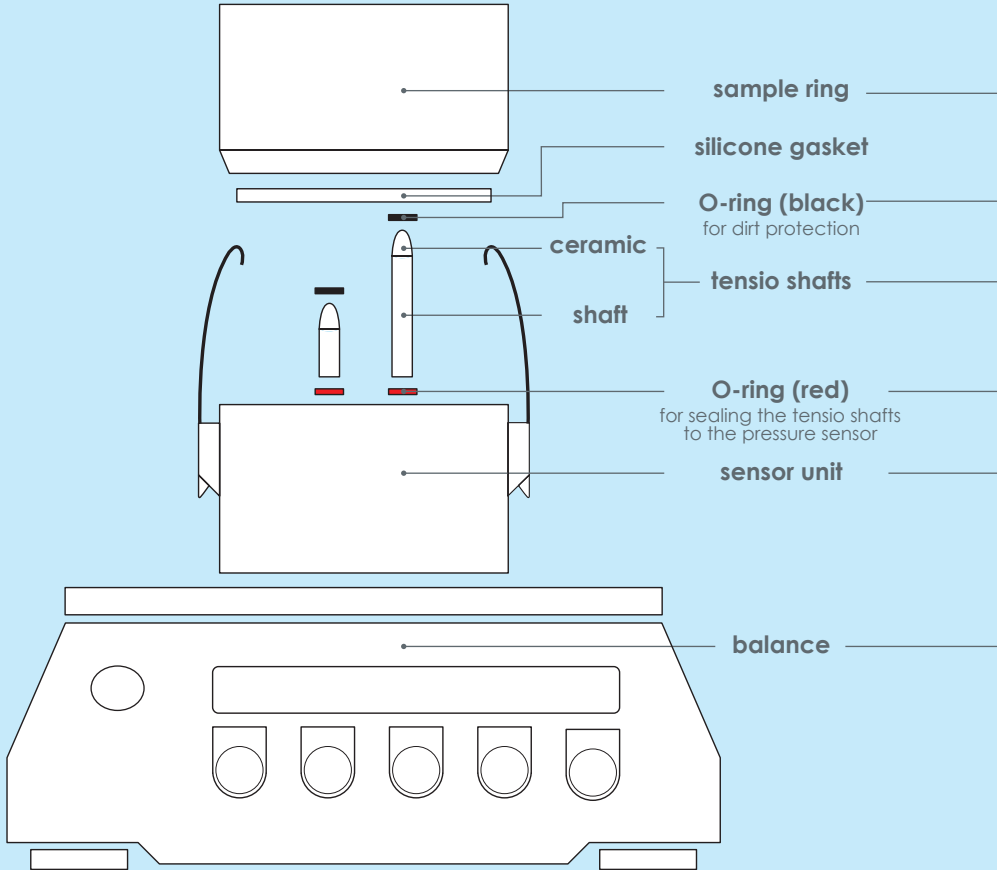

## Note

This manual does not describe the evaluation of the measuring data using the HYPROP-FIT software. For this please find another manual:

[www.metergroup.com/hyprop-2/#support](http://www.metergroup.com/hyprop-2/#support)





# Additional parts in the scope of delivery

silicone gasket and  
nonwoven cloths

HYPROP  
connecting cable

tensiolink®  
T-piece

plastic caps

O-rings



refilling attachment  
for sensor unit

saturation plate

sensor unit

tensio shafts  
50 mm and 25 mm

droplet syringe

vacuum syringe

reservoir syringe

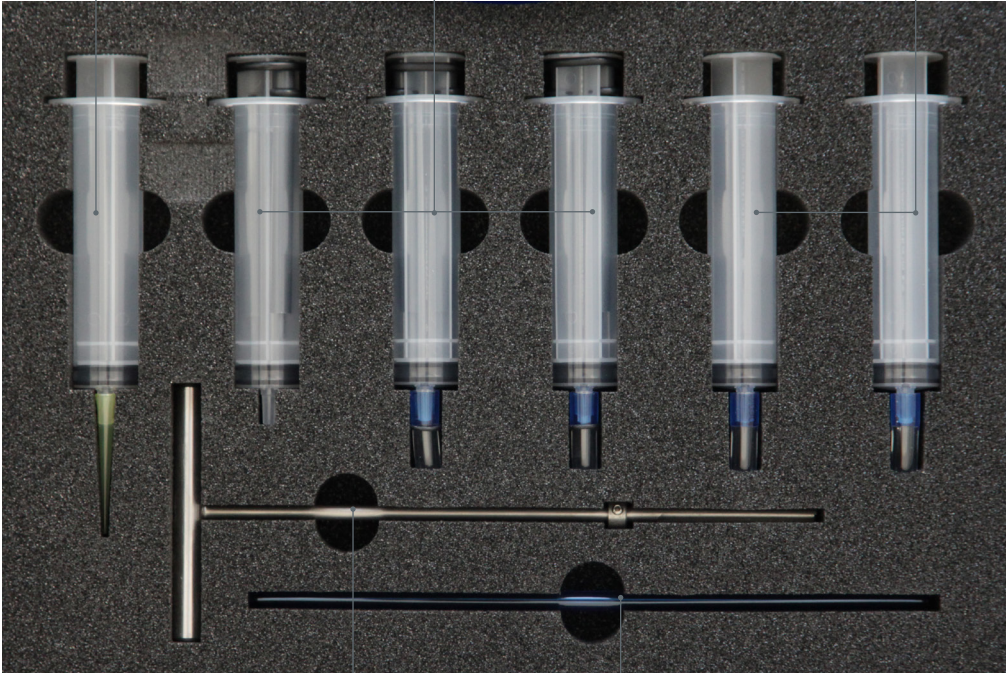

tensio shaft auger

tube for vacuum syringe and attachment for sensor unit

auger guide

HYPROP USB adapter



sample ring 250 ml  
with plastic caps

deionized water

power device

# Contents

<b>At a glance – how it works</b> .....	<b>4</b>
<b>Parts of the device and scope of delivery</b> .....	<b>5</b>
<b>Important information</b> .....	<b>13</b>
Safety instructions .....	13
Intended use .....	13
Warranty .....	13
<b>HYPROP-VIEW software functions</b> .....	<b>14</b>
Key functions .....	14
User support .....	14
Show devices .....	15
Device tree .....	16
<b>Initial operation</b> .....	<b>19</b>
Software installation: HYPROP-VIEW and HYPROP-FIT .....	19
LED indicators .....	20
Hardware configuration .....	21
How to use the tube connections .....	22
<b>General measuring procedure</b> .....	<b>23</b>
<b>Preparing the measurement</b> .....	<b>24</b>
Saturating the soil sample .....	24
Filling the device .....	26
using the Refill Unit (accessories) .....	27
using syringes .....	32
Offset recalibration .....	45
Implementing the tensio shafts in the sensor unit .....	47
Attaching the dirt protection .....	50
Function check .....	51
Assembling the sensor unit and the soil sample .....	53
Connecting the sensor unit and the balance .....	55
Preparing the balance .....	57
Adjusting.....	59
Default settings .....	61
<b>Measuring</b> .....	<b>62</b>
Multi balance mode (one balance per sensor unit) .....	62
Single balance mode (one balance for more sensor units) .....	63

<b>Optimal measuring curve</b> .....	<b>65</b>
Notes on suboptimal measuring curves .....	67
<b>Finishing a measurement</b> .....	<b>68</b>
<b>Determining the dry weight</b> .....	<b>71</b>
Weighing the dry mass .....	72
<b>Evaluating the measurement</b> .....	<b>73</b>
<b>Trouble shooting</b> .....	<b>74</b>
<b>Cleaning and maintenance</b> .....	<b>75</b>
Cleaning the sensor unit .....	75
Changing the O-rings in the sensor unit .....	76
Storage .....	77
<b>Additional accessories</b> .....	<b>79</b>
<b>Theory</b> .....	<b>81</b>
Preliminary note .....	81
Measuring method .....	82
Explanation of terms .....	83
Generating data points .....	85
Additional notes .....	87
<b>Addendum</b> .....	<b>89</b>
Typical measuring curves .....	89
Standard pF curves .....	96
Procedure of sampling for WP4 measurements after a HYPROP measurement .....	97
Units for soil water and matrix potentials .....	98
<b>Facts and figures</b> .....	<b>99</b>
Technical data .....	99
<b>Literature cited</b> .....	<b>100</b>



# Important information

## Safety instructions

Electrical installations must meet the safety and EMC requirements of the country in which the system is used. Damages caused by the user are not covered by the warranty. HYPROP is a device to measure soil tensions as well as soil water pressures and temperatures and is only intended for this particular use. Please keep the following notes in mind:

### Note

Please do not touch the ceramic of the tensio shafts with bare fingers. Grease or soap reduces the hydrophilic characteristics of the ceramic.

### Note

Do not stick sharp objects into the holes of the sensor unit. You may damage the pressure sensor.

## Intended use

HYPROP® is a measuring system that is intended to be used for measuring the water retention function and the hydraulic conductivity as a function of the water tension or the water content of soil samples.

## Warranty

METER Group AG offers a warranty for material and production defects for this device in accordance with the locally applicable legal provisions, but for a minimum of 12 months. The warranty does not cover damage caused by misuse, inexpert servicing or circumstances beyond our control. The warranty includes replacement or repair and packing but excludes shipping expenses. Please contact METER or our representative before returning equipment. Place of fulfillment is Mettlacher Straße 8, Munich, Germany.

# Software functions

## Key functions

The key functions are:

- displaying the connected devices,
- displaying the measurement data
- filling assistant
- measurement configuration wizard

The wizard is explained in the respective chapter.

## User support

### Note

After starting the software the user support leads you through all software functions. If you are an experienced user you may not like to use the wizard of the measuring configuration and enter the data directly instead. This is possible too.

### Example of user support: Help Function

When you start the software and the help function is activated notes of the next step are displayed, e.g. here you are asked to click on the "Show device" icon.

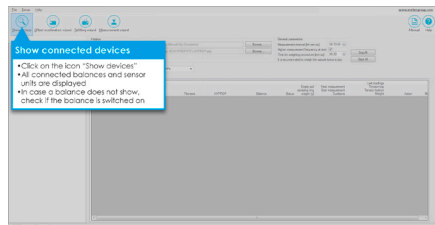

## Example of user support: Wizard

Click on an icon in the upper screen bar e.g. "Measurement".



Follow the wizard.



When all steps are done, click on "Apply" if you want to enter the configuration. If you click on "Cancel" you return to the initial page, where you have opened the wizard.

Start Measurement Wizard

Select HYPROP Device: Please select HYPROP device!

Enter sample name:

Enter file name: Browse...

Select balance:

Select sample ring:

Enter empty sample ring weight (\*):

Start measurement:

Optional (\*)

Close Apply

Data you have entered are set in the program.

## Show connected devices

Click on the icon "Show devices".



In case a balance does not show, check if the balance is switched on.

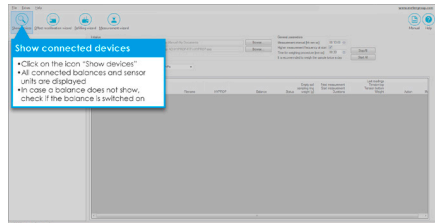

All connected balances and sensor units are displayed.



# The device tree (example)

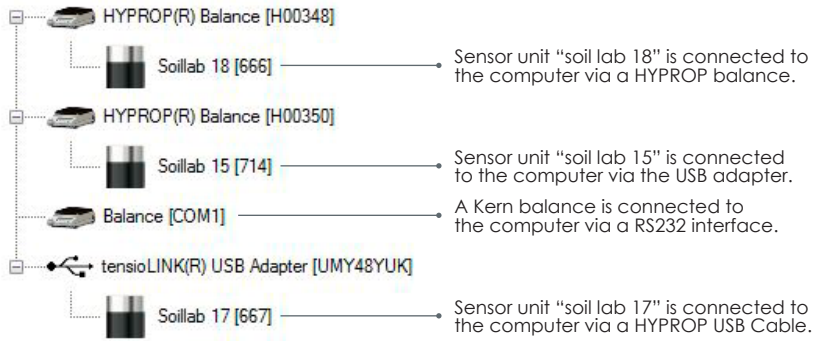

## Main window with manager

Mode (one or more balances)

Short cuts to key functions

Unit

Default folder for measurement files

Link to the HYPROP-FIT software

Interrupt, stop or start all measurements

Next step

Device ID (click right mouse button to change)

Connected devices

One measurement file per soil sample is generated

Data to be typed in by the user

Switches to displaying the measurement values when a measurement is running

www.metergroup.com

Manual Help

File Edit Help

Show devices Offset recalibration wizard Refilling wizard Measurement wizard

Default folder: \\LMS\SERVER1\fileserver\files\files\Documents

HYPROP-FIT App: C:\Program Files (x86)\METER Group AD\HYPROP-FIT\HYPROP.exe

General parameters

Measurement interval: 30.00 ms

Measurement interval at start: [X]

Higher measurement frequency at start: [X]

00:10:00 [Z]

Less All All All

Module: one balance per HYPROP Unit: tPa

Sample name	Type of sample etc.	Filename	HYPROP	Balances	Status	Empty soil sampling height [g]	Next measurement Start measurement Duration	Last readings Tension top Tension bottom Weight	Action	More
HYPROP-2 [1]			HYPROP-2 [1]	HYPROP Balance [S52006]	Configuration				Select Sampletime	
HYPROP- [2006]			HYPROP- [2006]	HYPROP Balance [S52006]	Configuration				Select Sampletime	
HYPROP-2 [1]			HYPROP-2 [1]	HYPROP Balance [S52006]	Configuration				Select Sampletime	

## Main window with measurement values

Stops the measurement

Opens the measurement file in HYPROP-FIT when the measurement is running

Runs an immediate measurement

Deletes all measurements performed

The screenshot shows the HYPROP-FIT software interface. At the top, there is a menu bar (File, Edit, Help) and a toolbar with icons for 'Show devices', 'Offset recalibration wizard', 'Ruffing wizard', and 'Measurement wizard'. Below the toolbar is a file tree on the left showing a project structure with folders like 'HYPROP-FIT Balance (H5500)' and files like 'HYPROP-FIT App'. The main area contains a status bar with 'Status: Running' and 'Measurement started: 15.02.2010 14:10:21'. To the right of the status bar are buttons for 'Stop measurement', 'Read', and 'Delete all measurements'. Below these buttons are two data visualization panels. The top panel is a line graph titled 'Tension bottom' and 'Tension top' showing tension in Pascals (Pa) over time from March 2010 to September 2010. The bottom panel is a line graph titled 'Weight' showing weight in grams (g) over the same time period. To the right of the graphs is a table with two sections. The top section is a table with columns 'Date / Time', 'Tension bottom (Pa)', 'Tension top (Pa)', and 'Temperature (°C)'. The bottom section is a table with columns 'Date / Time', 'Gross weight (g)', 'Net weight (g)', and 'Weight change (g)'. The table data is as follows:

Date / Time	Tension bottom (Pa)	Tension top (Pa)	Temperature (°C)
10.03.2010 09:52:33	1.05	0.64	20.45
10.03.2010 09:53:33	-1.43	0.89	20.47
10.03.2010 09:54:33	-1.38	0.91	20.46
10.03.2010 09:55:33	-1.33	0.97	20.46
10.03.2010 09:56:33	-1.28	0.99	20.45
10.03.2010 09:57:33	-1.26	1.08	20.45
10.03.2010 09:58:33	-1.16	1.13	20.44
10.03.2010 09:59:33	-1.17	1.20	20.44
10.03.2010 10:00:33	-1.12	1.23	20.42
10.03.2010 10:01:33	-1.05	1.29	20.43
10.03.2010 10:02:33	-1.01	1.38	20.42
10.03.2010 10:03:33	0.80	1.49	20.42

Date / Time	Gross weight (g)	Net weight (g)	Weight change (g)
10.03.2010 09:53:33	1040.34	481.34	-0.01
10.03.2010 09:54:33	1040.32	481.32	-0.03
10.03.2010 09:55:33	1040.31	481.31	-0.04
10.03.2010 09:56:33	1040.29	481.29	-0.0409
10.03.2010 09:57:33	1040.28	481.28	-0.07
10.03.2010 09:58:33	1040.27	481.27	-0.08

Display of the soil sample's tensions and weights over time (graphical)

Display of the soil sample's tensions and weights over time (tabular)

# Initial operation

Software installation: HYPROP-VIEW and HYPROP-FIT.

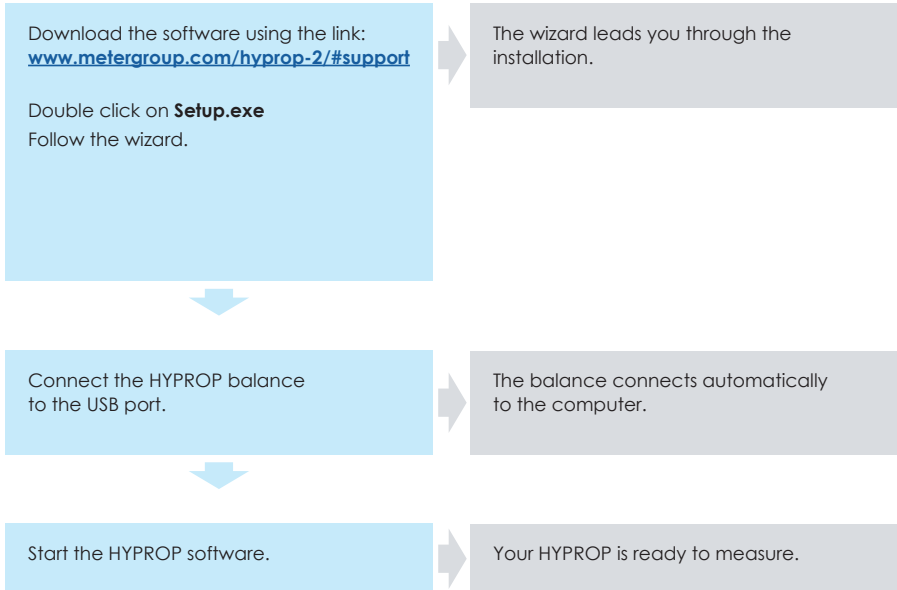

## Note

For installing the HYPROP software you may need administrator rights.

# LED Indicators

The status of the connected device is indicated by the LED light ring:

Color	Mode	Description
white	flashing, 3x	HYPROP® has been detected by the computer.
white	permanent	HYPROP® has been detected by the HYPROP VIEW Software. The device can be configured for measurement.
white	flashing	HYPROP® is ready for measurement.
blue	pulsing	HYPROP® measurement is in progress.
blue	permanent	HYPROP® measurement is finished.
red	permanent	during firmware update
red	flashing	Scale and/or HYPROP® was bumped or moved. Hardware error. Please contact vendor.

# Hardware configuration

## Change device ID

Each sensor unit needs its particular device ID otherwise a communication collision may occur.

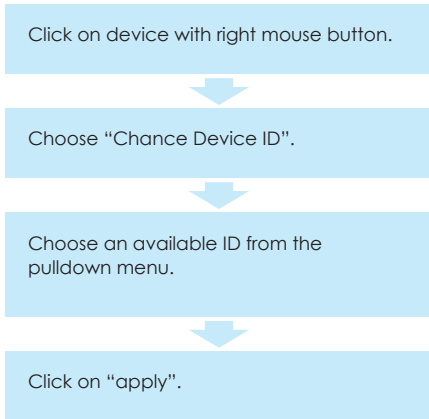

## Change device name (optional)

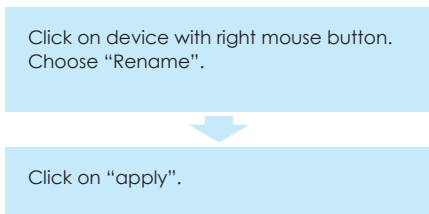

# How to use the tube connections

## Note

Cut the tube always rectangular otherwise the connection will be leaking.

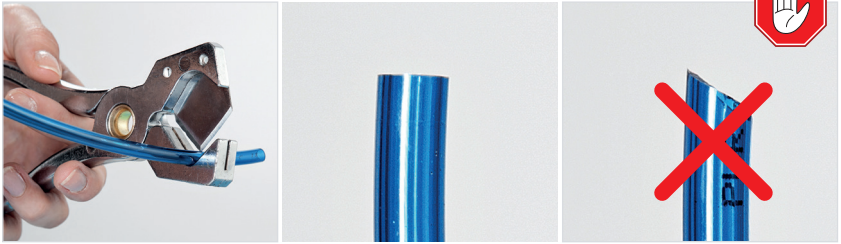

To **connect** the tube to the fitting push the tube in as far as it will go.



To **remove** the tube press blue ring and pull.



# General measuring procedure

A measurement consists of the following steps:

- soil sampling and preparation
- saturating the soil sample
- preparing the measuring system
- setting up the sample in the measuring system and starting the measuring campaign
- evaluating the measuring results with HYPROP-FIT.

In the following this manual will guide you through the measuring process step-by-step.



# Preparing the measurement

## Saturating the soil sample

Take the sample ring with soil out of the transport box and clean it. Prepare top and bottom side of the sample (e.g. with a saw blade).



Put a plastic cap upside down on the sample ring – on the side where the ring has the cutting edge. The cap works as a support. This makes sure that no soil gets lost even when loose sand is in the sample ring.

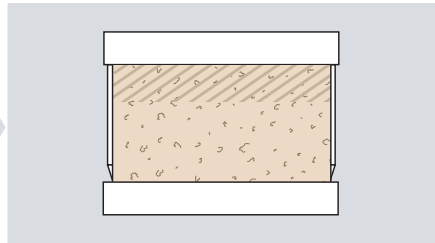

Turn soil sample upside down and put it on a table. Remove cap on top, place nonwoven cloth on the soil and put the filling bowl on the sample ring.



Turn soil sample again upside down.

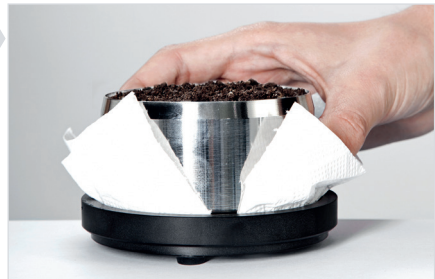

Fill 2 cm (1 in) of degassed water into a tray. Put the soil sample into the tray – tilt it so that air under the soil can escape.

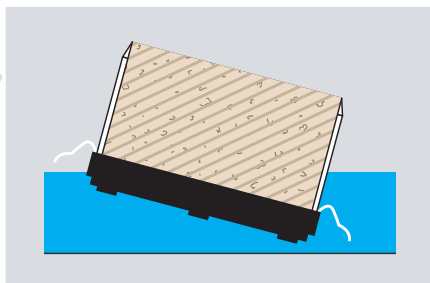

Put a plastic cap upside down on the sample ring. Do not fix it so that air can ventilate. The cap protects the soil from sun radiation and evaporation.

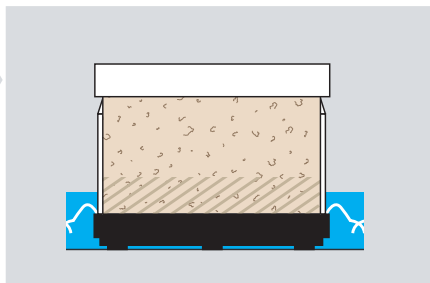

Raise the water level up to 5 mm below the sample rim (recommended times see below). Do not pour water on the sample – you may trap air. Use the time table below as a reference to determine how long samples take to saturate.

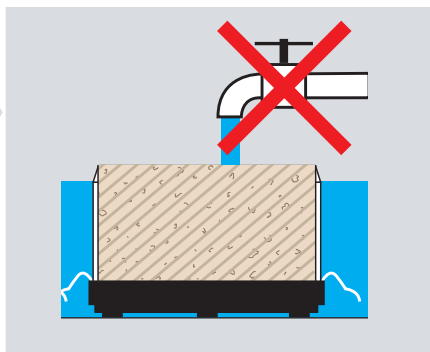

Let soil sample capillary saturate until the surface is shining.

**Note: Recommended time for saturation**

Material	Refilling after	Aufgesättigt nach
Coarse sands	about 9 min	about 10 min
Fine sands	about 45 min	about 1 h
Silts	about 6 h	about 24 h
Clay	n. a.	up to 2 weeks

## Filling the device

The tensio shafts “transduce” the matrix potentials (also called tensions) of the soil sample through their porous ceramic tip and the water filled shaft to the pressure sensors in the sensor unit. I.e. the tensio shafts provide via their pores a capillary contact between the water in the tensio shaft and the soil water.

To make sure the pressure is “transduced” precisely no air must be contained (dissolved or solved) in the water. That is why the tensio shafts and the sensor unit need to be degassed completely.

For degassing the water you can use two different methods:

1. by means of the Refill Unit (accessory) makes all necessary steps simple and is fast.
2. by means of syringes (basic scope of delivery) takes some more time and needs more manual work.

In the following either method is described in detail.

# Degassing the device using the HYPROP Refill Unit

## Scope:

High performance vacuum pump enables generating a vacuum value that is only 8 hPa (0.8 kPa).

Vacuum mount (including manometer and vacuum flask, to avoid water entry into the pump).

Beaker mount with 2 beakers. Up to 10 beaker mounts can be connected in series.

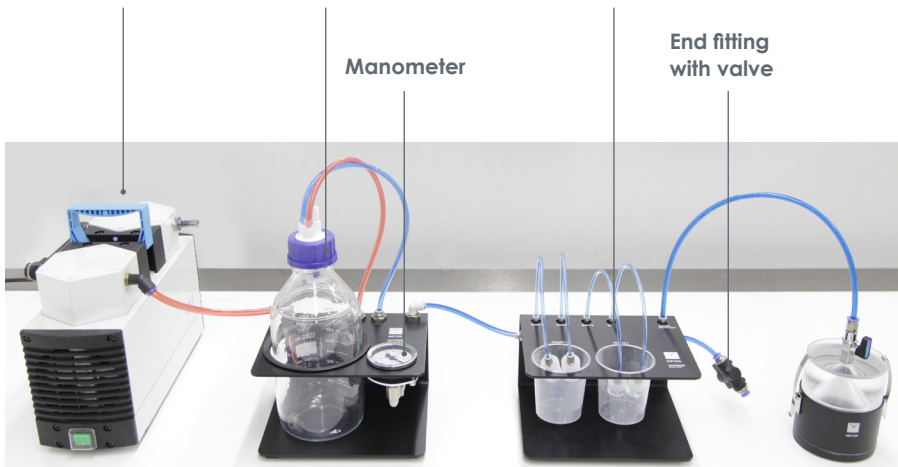

Put the vacuum pump on the ground (lower temperature) to gain better vacuum values.



#### Note

Do not touch the ceramic of the tensio shafts with bare fingers. Grease or soap reduces the hydrophilic characteristics of the ceramic.



The water in the tensio shaft evaporates to the ambient air. Therefore cover the tensio shaft tip with a silicone cap.



Connect the devices of the Refill Unit as shown. Tubes and fittings that need to be connected are indicated by the same color.

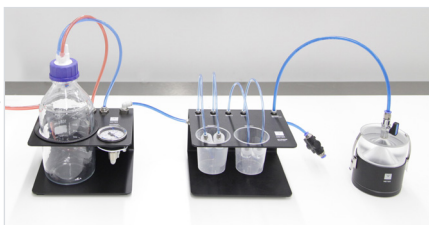

Connect the unit to a timer and the timer to the mains

#### Note

We recommend to use a timer as this increases the pump life, reduces energy consumption and air bubbles that may be there are ripped off when the pump starts. The timer is not in the scope of delivery as the electrical requirements vary from country to country.

We also recommend with every degassing procedure to degas an additional bottle of deionized water. You will need the water when you fill the tensio shafts.

# Filling the sensor unit



## Note

Do not stick the syringe tip into the holes of the sensor unit. You may damage the pressure sensor.

Fill holes of the sensor unit bubble free. For this use the droplet syringe.



Set up refilling attachment and fix it. Fill attachment with droplet syringe – ideally bubble free.



Screw 1, 2, 3 or 4 tensio shafts into the adapters.

Put blind plugs on connections not used.

Fill beaker(s) with deionized water.

Close valve of the beaker unit.

Set timer according to a rhythm of e.g. 5 min "on" and 55 min "off".



Timer starts the pump automatically and works in the rhythm set. The water in the tensio shafts is degassed after minimum 24 hours running time.

#### Note

If the manometer of the vacuum mount drops rapidly the system is leaking. Please check, fix leakage and restart degassing procedure. If you use another pump than the HYPROP pump, make sure that it is able to provide a vacuum value that is 8 hPa (0.8 kPa) below atmospheric air pressure. The power does not matter! Vacuum pumps that reach only a smaller vacuum value are not suitable.

## Bringing the HYPROP Refill Unit back to ambient pressure

Turn pump off. Open valve slowly and cautiously.

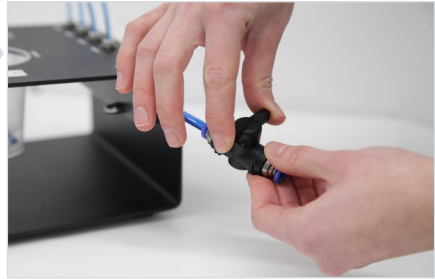

### Note

Never remove a tube in order to ventilate the system. The sudden pressure shock will damage the pressure sensors in the sensor unit.

When the water in the tensio shafts and the sensor unit has been degassed you can continue to set up the HYPROP (see chapter "Implementing the tensio shafts into the sensor unit").



# Degassing the device using syringes

If you have time put the tensio shafts in deionized water over night. Then the degassing takes less time. No water must enter the shaft from above, otherwise air will be locked in the pores.

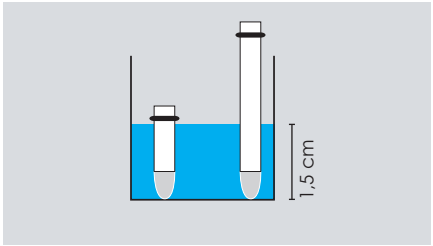

## Note

Do not touch the ceramic of the tensio shafts with bare fingers. Grease or soap reduces the hydrophilic characteristics of the ceramic.



The water in the tensio shaft evaporates to the ambient air. Therefore cover the tensio shaft tip with a silicone cap.



## Filling the tensio shafts

- ① Fill reservoir syringe with 10 ml deionized water.  
Turn syringe upside down and remove residual air.



- ② Close reservoir syringe tightly with your finger, pull plunger completely and hold it.  
The vacuum in the syringe degasses the water. Air bubbles show.



- ③ Toss and turn reservoir syringe to "catch" air bubbles.



④ Turn syringe upside down and remove residual air.



Repeat step ① to ④ until air bubbles do no show anymore.



Push tube piece onto the tip of the syringe. Push plunger of the syringe until a meniscus builds up on the tube piece.

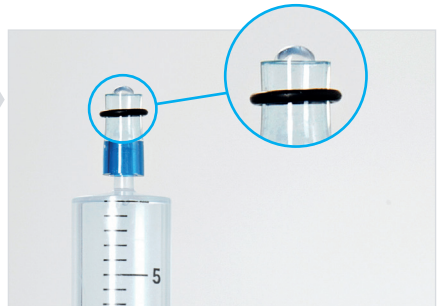

Push the ceramic of the first tensio shaft into the tube piece.

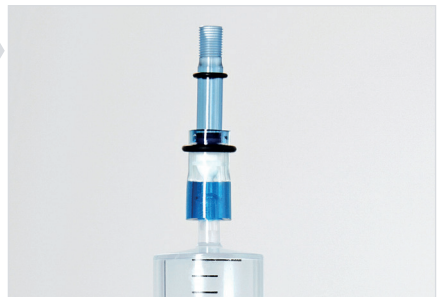

Fill vacuum syringe with 5 ml deionized water. Turn syringe upside down and remove residual air.



Degas water in the vacuum syringe – analogous to degassing the reservoir syringe.



Push tube piece over the tip of the syringe. Push plunger of the syringe until a meniscus builds up on the tube piece.

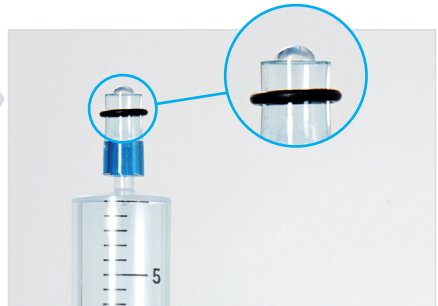

Connect the two syringes and the tensio shaft.  
The two O-rings help seal the tubes against the tensio shaft.



① Pull out the plunger of the vacuum syringe ...



... until the plunger stoppers snap in. The vacuum in the syringe removes the air from the tensio shaft.



② Hold plunger and syringe, press in the plunger stoppers and let the plunger slowly move forward.



- ③ Remove syringe, turn it upside down and remove residual air.



- ④ Push vacuum syringe bubble free onto the tensio shaft again.



Degas water in the second tensio shaft.

For this repeat step ① to ④ until air bubbles do not show anymore.





## Filling the sensor unit

Fill holes of the sensor unit bubble free with deionized water. Use droplet syringe.



### Note

Do not stick the syringe tip into the holes of the sensor unit. You may damage the pressure sensor.

Set up refilling attachment and fix it. Fill attachment with droplet syringe – ideally bubble free.



Fill vacuum syringe with 15 to 20 ml deionized water. Degas water in the syringe as explained on the previous pages.

- ① Push blue tube piece onto the vacuum syringe and fill the tube.



- ② Connect blue tube onto to the fitting of the refilling attachment.
- ③ Pull out the plunger of the vacuum syringe until the plunger stoppers snap in.

The vacuum in the syringe removes the air from the sensor unit and its attachment. Air bubbles show.



#### Note

Be extremely cautious! Do not let the plunger of the syringe shoot down as the pressure shock will damage the pressure sensor.

- ④ Let the air bubbles rise up into the tube by cautiously knocking and shifting the sensor unit.



#### Note

In no case push the sensor unit on a hard surface! The impact will cause pressure shocks that damage the pressure sensors.



- ⑤ To relieve pressure hold plunger and syringe, press in the plunger stoppers and let the plunger slowly move forward.



#### Note

Be extremely cautious! Do not let the plunger of the syringe shoot down as the pressure shock will damage the pressure sensor.

- ⑥ Remove syringe from the tube, turn it upside down and remove residual air.



Repeat steps ① to ⑥ until air bubbles do not show anymore.

Push vacuum syringe filled with degassed water into the tube on the refilling attachment. Pull plunger until the plunger stoppers snap in. The pressure shown on the screen must reach a vacuum value equal to the atmospheric air pressure minus 20 hPa (2 kPa). If this value can be reached the sensor unit is ready to measure after about 3 hours.

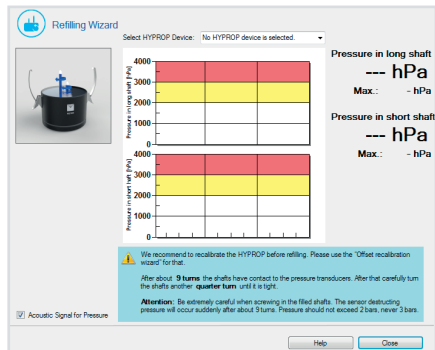

## Note

If the vacuum value does not reach a pressure equal to the atmospheric air pressure minus 20 hPa (2 kPa), then there is most likely:

- a dead volume in the syringe,
- air in the tube
- or a leakage in the system (e.g. between the sensor unit and the attachment)

After you have fixed the problem you need to degas the system again.

# Offset recalibration

In the course of time the offsets of the electronic HYPROP sensors may slightly drift. When you click the function "Offset Recalibration" the device checks automatically if the offset values are within the narrow range set by METER. Are they are out of range the device recommends to run an offset recalibration.

## Note

The offset recalibration can be done before every measurement as a routine to prepare the sensor unit.

Fill and degas sensor unit (please find description in the previous chapter).



Carefully remove sensor unit adapter, so that all the water from inside is collected on the up side of the sensor unit.



Connect sensor unit to the USB adapter.



Click the "Offset Recalibration" icon.

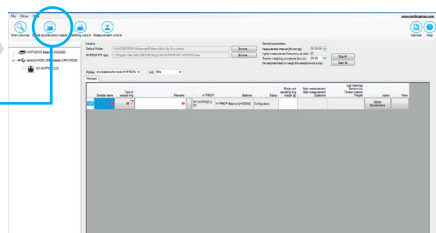
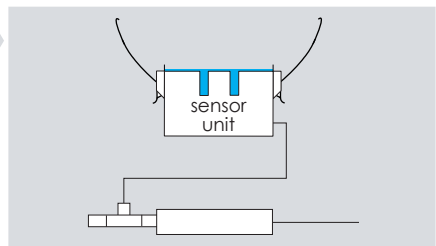
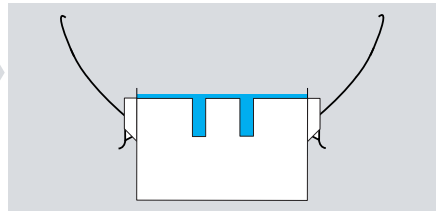

Select the sensor unit to be recalibrated.

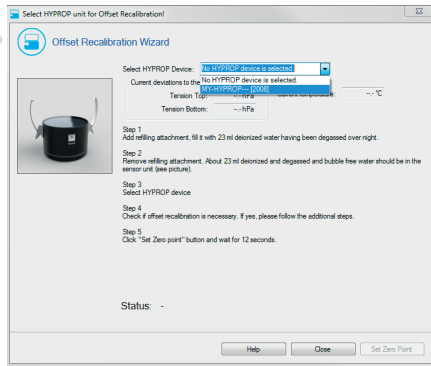

Check if the device recommends a recalibration.  
If not, you can stop the recalibration by a click on "Close".

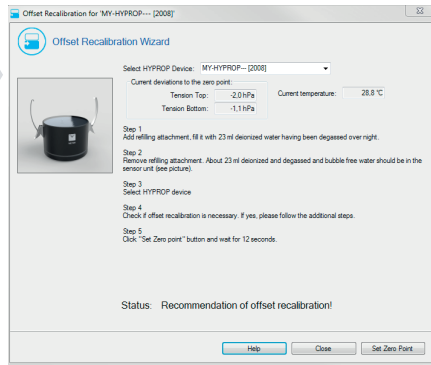

If yes go through the next steps according to the wizard.

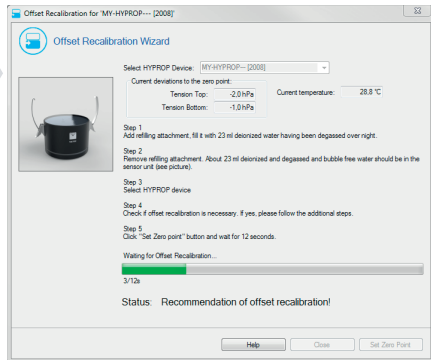

Click "Set Zero Point" and wait until the recalibration has been finished.  
Close the window by a click on "Close".

## Note

For the offset recalibration as well as for the following implementation of the tensio shafts please connect the sensor unit directly to the PC. Do not use the connection balance - sensor unit.

# Implementing the tensio shafts in the sensor unit

Put silicone tube on the ceramic tip of the tensio shaft. Turn tensio shaft upside down and fill it with deionized and degassed water until a meniscus builds up.



## Note

Fill tensio shaft only with degassed water otherwise air bubbles build up.  
The ceramic of the tensio shafts must be kept wet.  
For the following steps it is necessary to connect the sensor unit with the computer.  
So you can monitor the pressure increase when you screw in the tensio shafts. And make sure that the pressure sensors will not be damaged.



Connect sensor unit to the USB adapter.

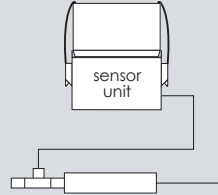

Click on the icon "Refilling".

Follow the wizard.

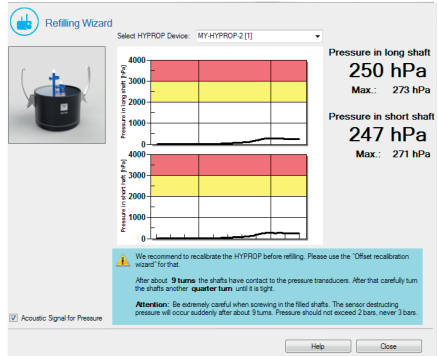

- ① Fill deionized water into the silicone tube piece.
- ② Screw in tensio shaft.
- ③ Monitor the tension values on the screen.
- ④ After about 9 turns the O-ring in the sensor unit starts sealing and the pressure increases rapidly.
- ⑤ Screw in the tensio shaft by another **quarter of a turn**.





### Note

Be extremely cautious when you screw in the tensio shafts filled with water. The pressure that can damage the pressure sensor increases abruptly at about 9 turns. This pressure should not exceed 2000 hPa (200 kPa) – and in no case 3000 hPa (300 kPa).

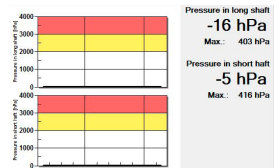

Repeat all steps for the second tensio shaft.



When all steps are done click on "Close" and you get to the page where you opened the refilling wizard.

### Note

If you open the wizard during a measurement the measuring process is interrupted. Therefore the wizard is closed automatically after 2 min and the measurement is continued.

# Attaching the dirt protection

- ① Push black O-ring for dirt protection on the tensio shaft until it sits in the groove of the sensor unit.
- ② Remove silicone tubes from the tensio shaft tips.
- ③ Put silicone gasket on the sensor unit.
- ④ Cover tensio shaft tips again with silicone tubes and fill them with deionized water.

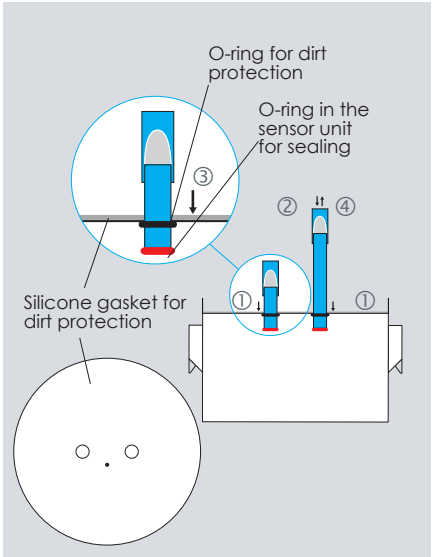

- ⑤ Fill the silicone tubes immediately with deionized water.

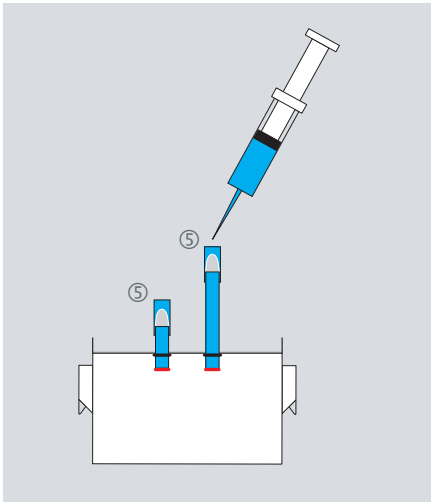

# Function check

Connect sensor unit to the USB adapter.

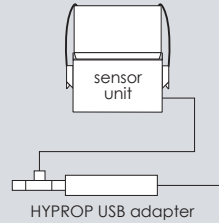

Click on the "Refilling" icon.

The screenshot shows the 'Refilling Wizard' software window. At the top, it says 'Select HYPROP Device: MY-HYPROP-2 [1]'. Below this is a small image of the device and two pressure graphs. The top graph is labeled 'Pressure in long shaft (hPa)' and shows a pressure of 250 hPa with a maximum of 273 hPa. The bottom graph is labeled 'Pressure in short shaft (hPa)' and shows a pressure of 247 hPa with a maximum of 271 hPa. A warning message states: 'We recommend to recalibrate the HYPROP before refilling. Please use the "Offset recalibration wizard" for that.' Below the warning, it says: 'After about 9 turns the shafts have contact to the pressure transducers. After that carefully turn the shafts another quarter turn until it is tight.' A note below that says: 'Attention: Be extremely careful when screwing in the filled shafts. The sensor detaching pressure will occur suddenly after about 9 turns. Pressure should not exceed 2 bars, never 3 bars.' There is a checkbox for 'Acoustic Signal for Pressure' which is checked. At the bottom right are 'Help' and 'Close' buttons.

## Checking the zero point

- ① Put a drop of water on the ceramic tip of the tensio shaft. By this zero potential exists.
- ② The screen should indicate zero pressure for both tensio shafts.

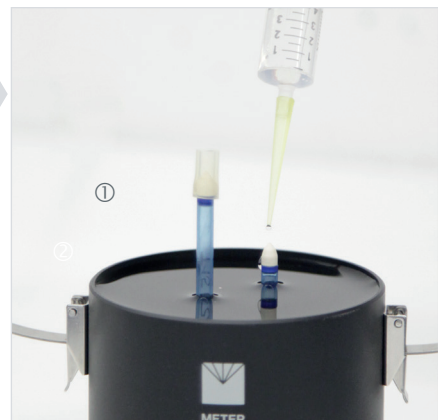

## Checking the speed of response

- ① Keep a syringe filled with deionized water on hand.
- ② Remove silicone tube from the long tensio shaft and dry the ceramic tip with a paper towel.
- ③ Use a sheet of cardboard and fan air to the ceramic. Monitor the pressure display on the screen.

The pressure should increase up to the atmospheric air pressure minus 100 hPa (10 kPa) within 15 seconds.



## Checking the end vacuum

- ④ As soon as the pressure has reached the atmospheric air pressure (e.g. 100 hPa or 10 kPa) wet the ceramic **immediately** with deionized water. Otherwise air may enter the tensio shaft and the degassing process has to be repeated!
- ⑤ Put silicone tube on tensio shaft and fill up.

Repeat steps ① to ⑤ for the short tensio shaft.

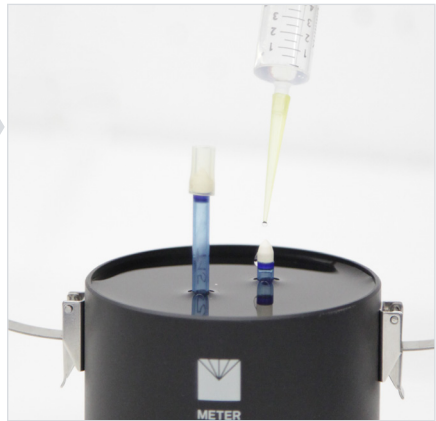

### Note

If the pressure does not rise to tensions close to atmospheric air pressure minus 100 hPa (10 kPa), highly likely air is in the tensio shaft. Then degassing the water in the sensor unit has to be repeated!

Other potential failures:

- tensio shaft does not sit tightly on the O-ring,
- tensio shaft is clogged (e.g. by oils from fingers)
- O-ring of the tensio shaft is worn out.

# Assembling the sensor unit and the soil sample

## Drilling the holes

- ① Set tensio shaft adapter onto the saturated soil sample in the tray. The small hole should be above the sample ring number. This makes finding the right position easier when the sensor unit and the soil sample are assembled.
- ② Use the tensio shaft auger to drill the holes. Carefully drill in 10 mm steps and make sure the soil sample is not compressed.



Fill drill holes with water to make sure air will not be pressed into the soil sample during assembly.



- ① Set the sensor unit cautiously upside down onto the soil sample. Make sure, no air gaps are generated and the soil is not compressed.

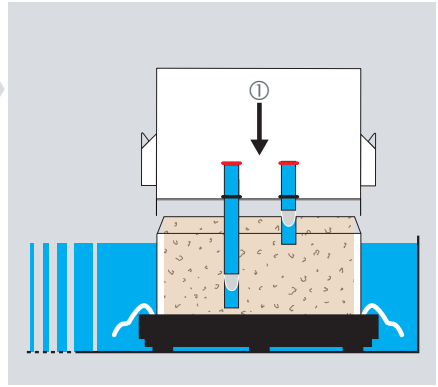

- ① Turn the whole test assembly upside down.
- ② Remove saturation plate and nonwoven cloth.



- ① Fix soil sample with the clips.
- ② Carefully clean the sample ring and clips and dry them. Otherwise water and dirt will be weighed too.

The soil sample is now ready to be measured.



# Connecting the sensor unit and the balance

## Multi balance mode

(i.e. one balance per sensor unit)

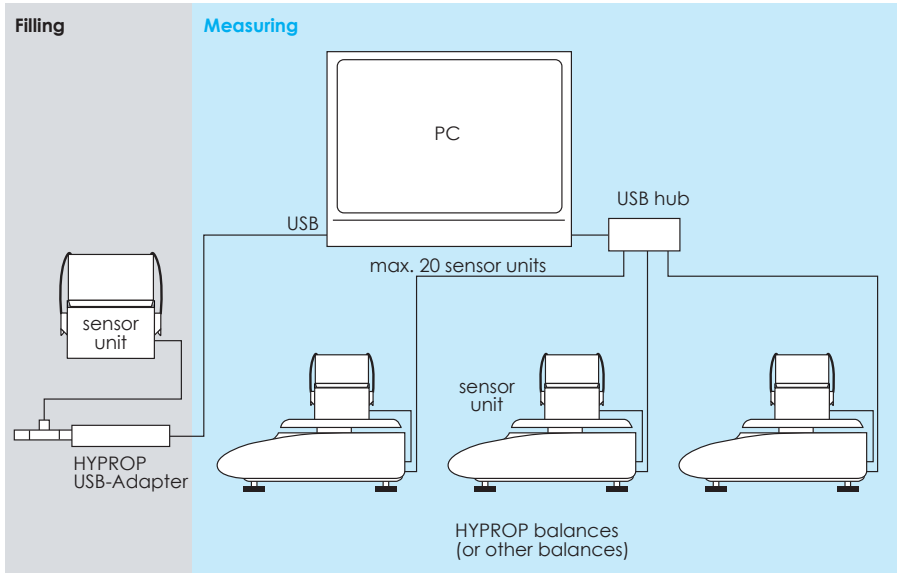



## Single balance mode

(i.e. one balance for more sensor units)

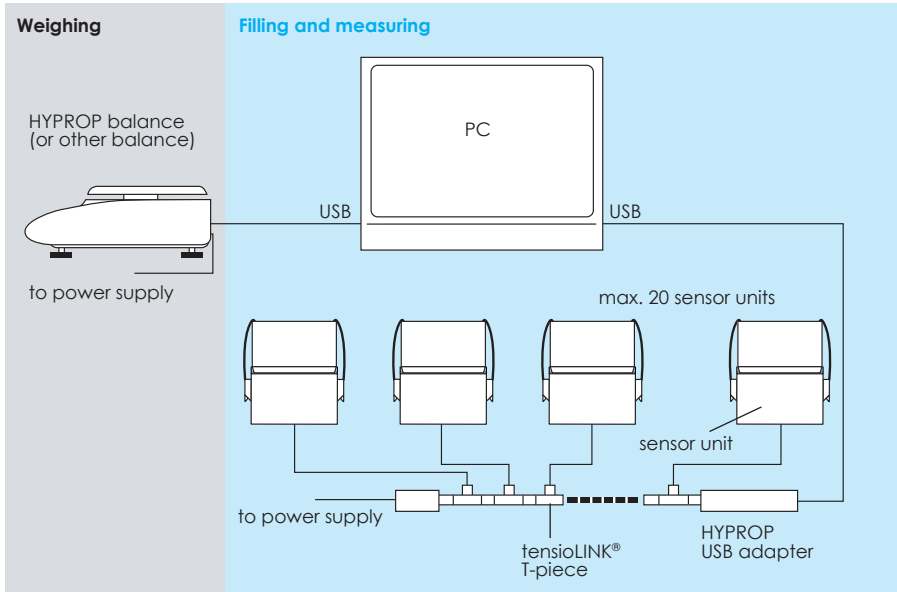

# Preparing the balance

## Set-up

The balance should be set up on a vibration-free work place that is ideally used for HYPROP measurements only.

- ① Set up the balance horizontally.
- ② Adjust the balance by turning the balance feet. The air bubble should be in the center of the level.

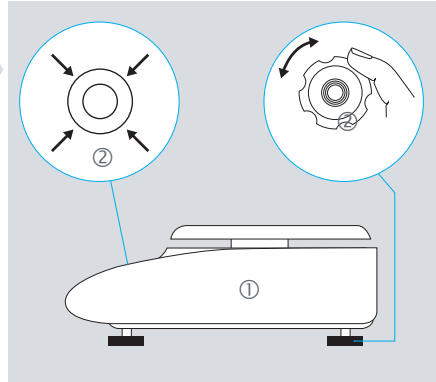

- ① Connect the balance to the power supply and computer and turn it on.
- ② Connect the cable of the sensor unit to the balance and fix it on the magnet clamp.
- ③ Put the free end of the cable and the plug on the balance. Push the "Tara" button and set the display to zero.

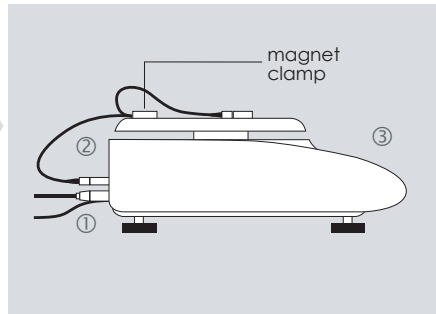

Connect the sensor unit and put it on the balance.

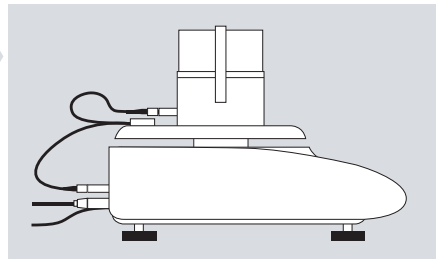



### Note

The both ends of the sensor unit cable must not touch each other as this would lead to noisy measurements.

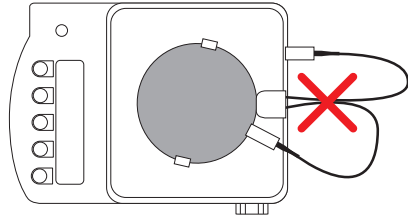

# Adjusting

For precise measurements the balance needs to be adjusted to the local conditions:

- when it has been set up initially
- after a change of position
- after a temperature change.

We recommend adjusting the balance also every **4** weeks when the balance is in measuring operation. For its adjustment the balance is equipped with an adjusting weight.

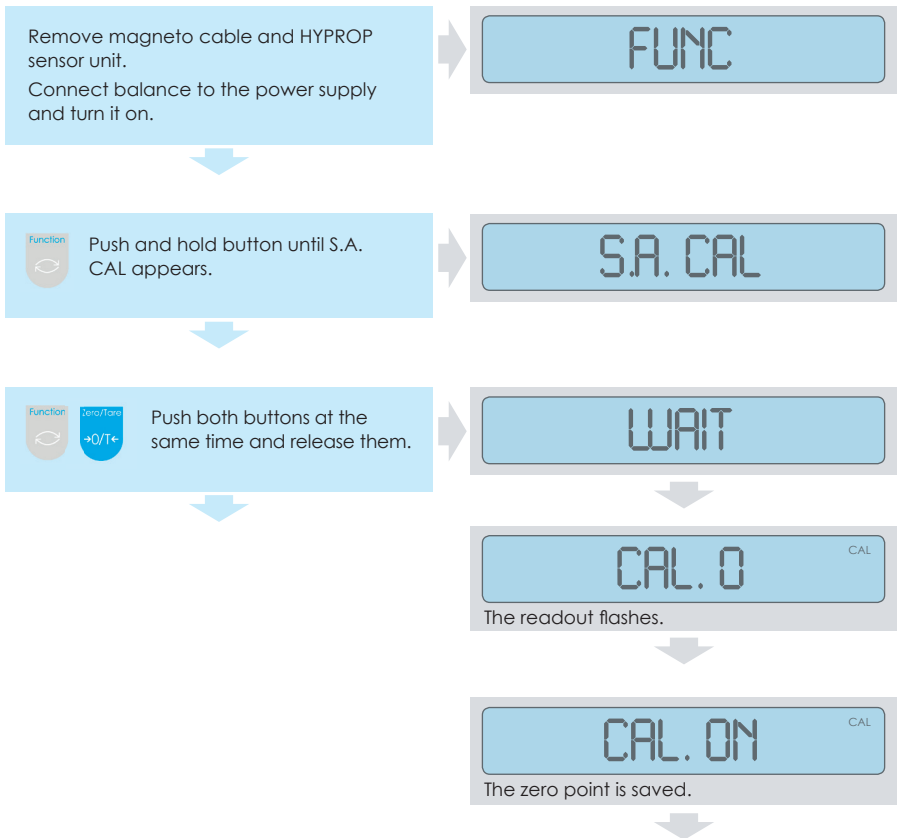

Turn balance knob to "CAL".

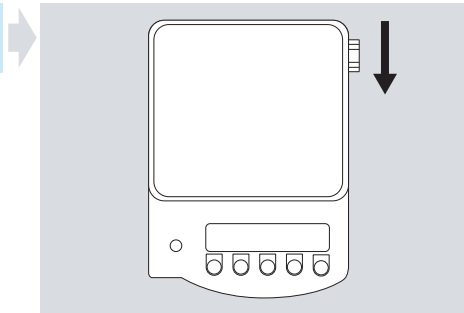

CAL. ON

CAL

The readout flashes and the adjustment runs automatically.



CAL. OFF

CAL

The adjustment is done.

Turn balance knob to "WEIGH".

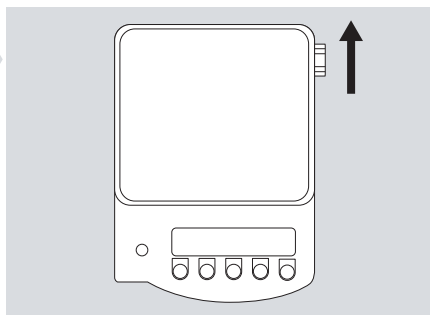

BUSY

CAL



END.

The balance is adjusted and ready to weigh.

#### Note

The weight shown on METER sample rings refers to  $g = 9.80665 \text{ m/s}^2$ .

# Default settings

Function	Display	Adjustment
Bar graph	1 B.G. 1	On
Toleranzwiegung	2 SEL 0	Off
Nullabgleich	3 A.O 1	Automatic zero point correction activated.
Automatic shut off after 3 min (rechargeable battery operation)	4 A.P. 1	On
Readout speed	5 RE. 3	medium speed
Vibration filter	6 S.D. 2	medium sensitivity
Interface	7 I.F. 1	6 digit data format

# Measuring

## Multi balance mode (one balance per sensor unit)

Click on the "Show devices" icon.



If the balance does not show on the screen check if balance is turned on.



Click on the "Measurement wizard" icon.



Enter the following data – either via the wizard or directly in the manager:

- measuring mode,
- measuring unit,
- name of the soil sample,
- sample ring type and
- balance type.

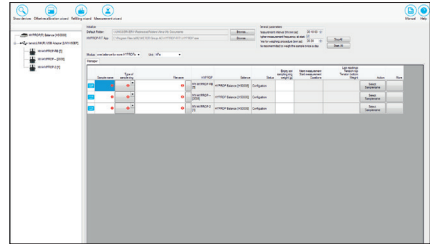

Next Measurement	Last Measurement	Tension Top Current (Max) [FPa]	Tension Bottom Current (Max) [FPa]	Weight [g]	Action	More
					Select Balance	More...
					Select Filename	Map...

After entering the  data the key legend changes to "Start".

**Start**

Push start button.

Next Measurement	Last Measurement	Tension Top Current (Max) [FPa]	Tension Bottom Current (Max) [FPa]	Weight [g]	Action	More
					Select Balance	More...
					Select Filename	More...

Actual and maximum tension value of the upper and lower tensio shaft in minute cycle)

Actual sample mass (in minute cycle)

### Note

The magneto cable from the balance to the magnet clamp must lie freely as a loop without touching anything.  
Before you start weighing wait for at least 5 minutes to let the cable tension release.

# Single balance mode

(one balance for more sensor units)

Click on the "Show devices" icon.



If the balance does not show on the screen check if balance is turned on.



Click on the "Measurement wizard" icon.



Enter the following data – either via the wizard or directly in the manager:

- measuring mode,
- measuring unit,
- name of the soil sample,
- sample ring type and
- balance type.

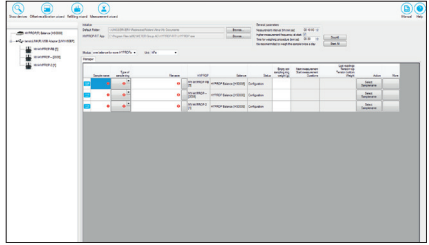

Next Measurement	Last Measurement	Tension Top Current (Max) [FPa]	Tension Bottom Current (Max) [FPa]	Weight [g]	Action	More
					Select Balance	More...
					Select Name	Map...

After filling in the  data the key legend changes to "Start".

**Start** Push start button.



Next Measurement	Last Measurement	Tension Top Current (Max) [FPa]	Tension Bottom Current (Max) [FPa]	Weight [g]	Action	More
					Select Balance	More...
					Select Name	Map...

Actual and maximum tension value of the upper and lower tensio shaft (in minute cycle)

**Note**

The magneto cable from the balance to the magnet clamp must lie freely as a loop without touching anything. Before you start weighing wait for at least 5 minutes to let the cable tension release.



## Weighing the sample mass

In the single balance mode we recommend to weigh the sample mass twice a day.

Remove plug from sensor unit.

The system identifies automatically the sensor unit having been put on the balance.

### Note

Only one sensor unit may be disconnected. Please do not pull the magneto cable but use the serrated area of the plug instead.  
The number of samples is limited to 20.

Follow the instructions on the screen.

A menu opens on the screen showing information about the status and the weighing routine.

Next Measurement	Last Measurement	Tension Top Current (Max) [N]	Tension Bottom Current (Max) [N]	Weight [g]	Action	Menu
					Select Balance	More...
					Select Hierarchy	More...

Actual sample mass

Disconnect sensor unit from the balance and connect it again to the T-piece of the tensioLINK®. This function is supported with a menu.

The screenshot shows a window titled "Status - Soillab 09". On the left is an image of a laboratory scale with a container on top. On the right, under the heading "Weighing procedure: Soillab 09", there is a table with columns "Task" and "Status".

Task	Status
Remove previous stuff from the scale!	Wait
Place sensor unit Soillab 09 on the scale.	-
Reading weight of Soillab 09.	-
Re-connect Soillab 09 to tensioLINK.	-

At the bottom right of the window is a "Cancel" button.

The menu leads you through the weighing procedure.

### Note

If you run more sensor units with one balance the magneto cable is not needed.

# Optimal measuring curve

Every measurement runs in 4 phases provided that tensio shafts and sensor unit are filled air free.

## **Phase 1, regular measurement range**

Tension value curve rises up without flattening until it reaches the boiling point of the water.

## **Phase 2, boiling delay phase**

In the ideal case – when the system is filled completely air free – the tension value rises up to the boiling delay area (above the ambient air pressure). This is nice to have but in general not necessary for the evaluation.

## **Phase 3, Cavitation phase**

Water vapor is generated in the tensio shaft and the tension value drops abruptly down to the boiling point. After this the tension value decreases only slightly.

## **Phase 4, Air entry phase**

The tension value again drops abruptly – now to zero, as air penetrates the ceramic. The air entry point is a material characteristic of the ceramic and amounts to about 8800 hPa (880 kPa). This point can also be used for the evaluation.

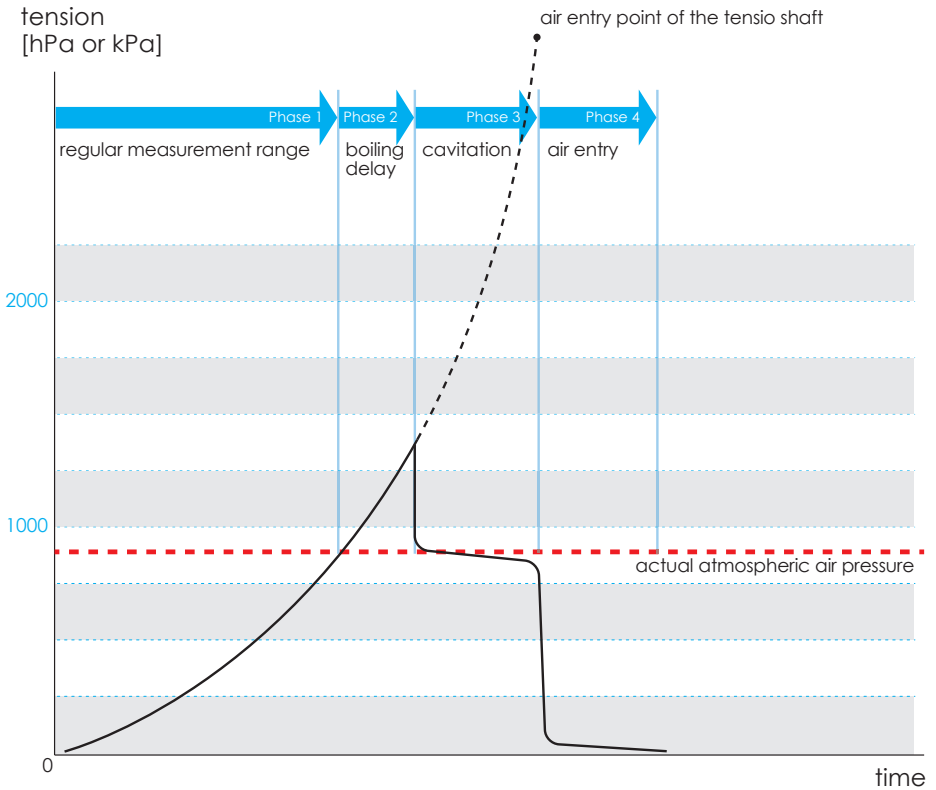

The four phases using one tensio shaft as example

————— measured values      - - - - - interpolated values

# Notes on suboptimal measuring curves

Often the optimal measuring curve up to the boiling delay cannot be achieved. The curves then look similar to the example below. But even these curves can be used for an evaluation. In the chapter "Addendum" you find exemplary measuring curves of various soils.

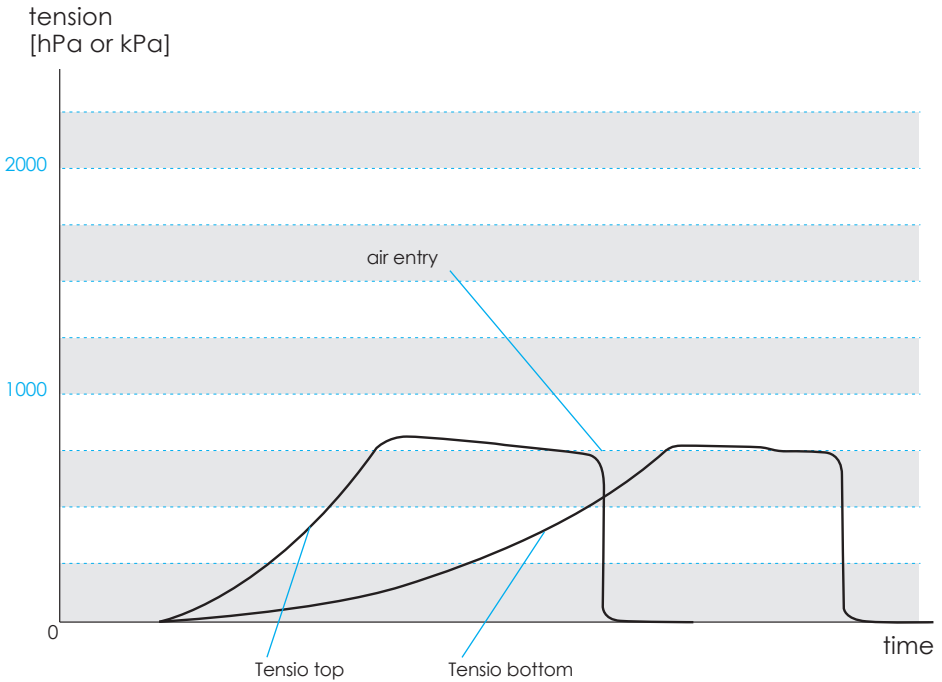

# Finishing a measurement

You can finish a measurement in three ways:

1. You stop when the upper tensio shaft has reached the cavitation phase (see illustration 1). Then you do not use the air entry point.
2. You are willing to use the air entry point. Then there are two possibilities:
  - a) The air entry point of the first tensio shaft has been reached and the second tensio shaft is still in the regular measurement range (phase 1) or in boiling delay (phase 2). In this case HYPROP can calculate the medial value of the Tensio top and Tensio bottom curve (see illustration 2).
  - b) When the air entry point of the first tensio shaft has been reached and the second tensio shaft is still in the cavitation phase (phase3), the medial value of the two cannot yet be calculated. Then please wait until the air entry point of the second tensio shaft has been reached (see illustration 3).

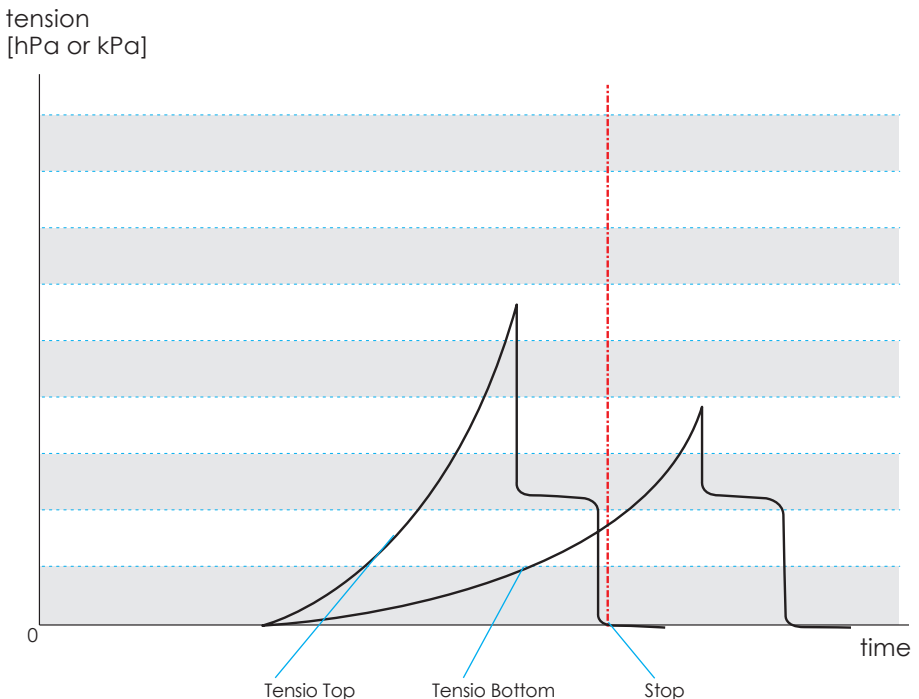

Illustration 1

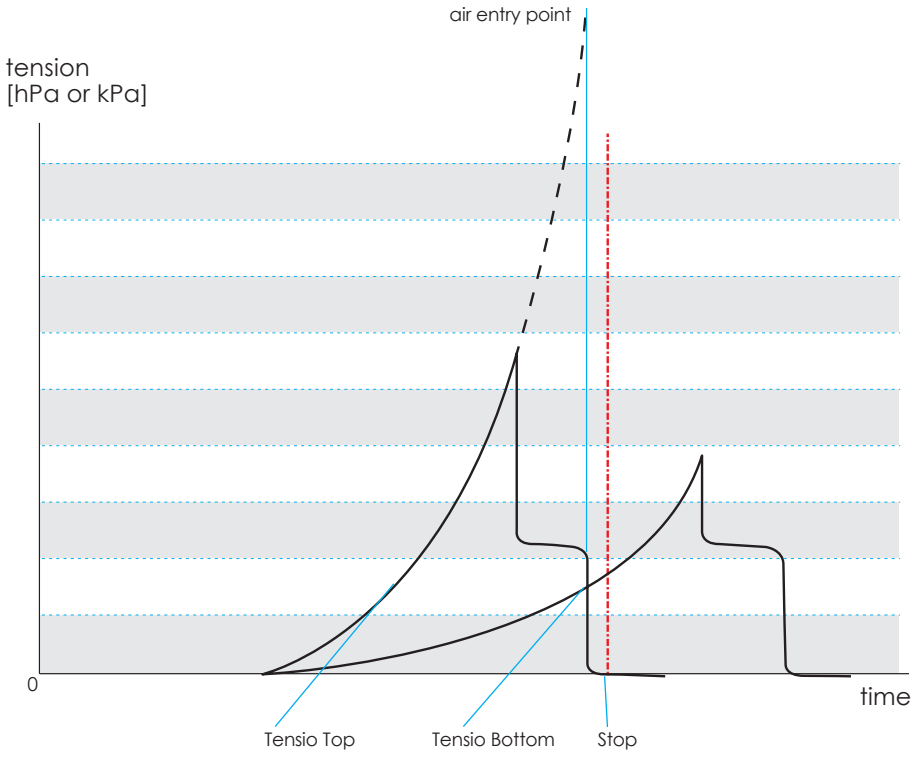

Illustration 2

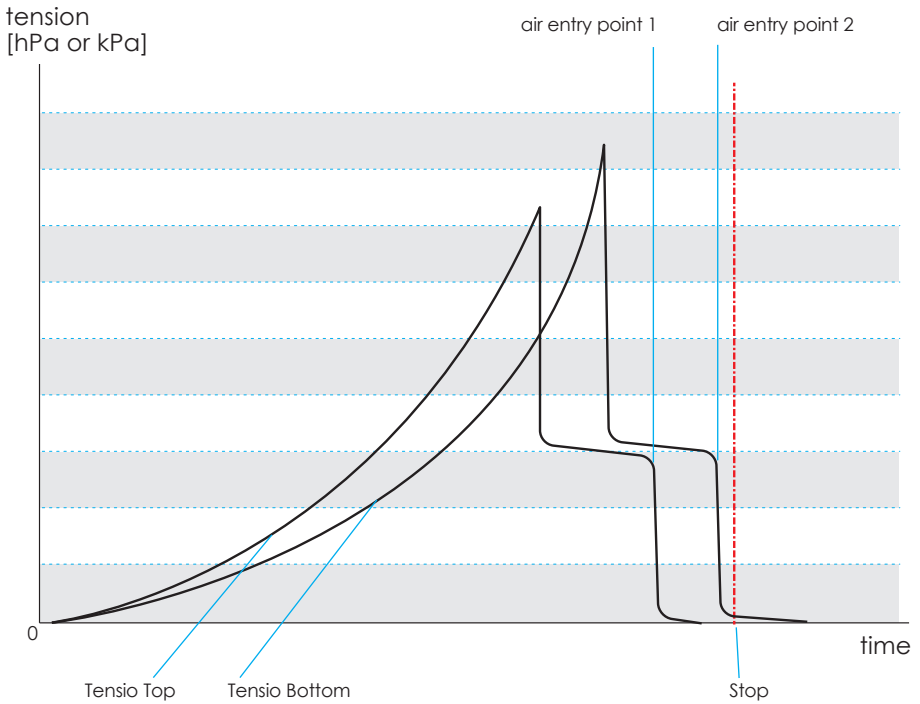

Illustration 3

**Stop**

In either case click the "Stop" button to finish the measurement.

After this you can have the software HYPROP FIT evaluate the measuring values. For this please see the manual using this link:

[www.metergroup.com/hyprop-2/#support](http://www.metergroup.com/hyprop-2/#support)

# Determining the dry weight

HYPROP needs the dry weight of the soil sample to be able to calculate the volumetric water content based on the weight reduction. Therefore the sample has to be weighed after the measuring campaign.

Put the soil sample in a bowl (ideally in a heat resistant one, so that you can put it in the oven for drying).  
Open the clips of the sensor unit.  
Cautiously remove the sample ring.  
Do not tilt the sample ring. If you do so you may break the tensio shafts.

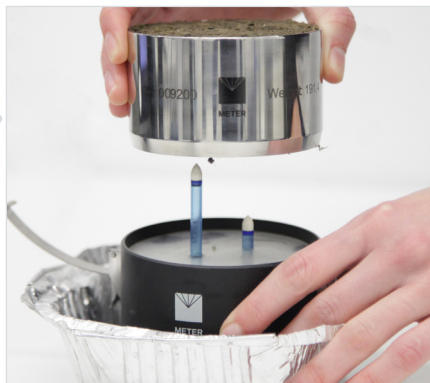

## Note

If the soil sticks too tightly to the sensor unit (which is often the case with clayey soils) put the sample ring with the sensor unit upside down in water. The water level should be above the rim of the sample ring. If necessary leave it in the water over night. Then the sample ring can be removed more easily.

Collect the soil material completely in the bowl.





Clean also sample ring and silicone gasket above the bowl to avoid losses.



## Weighing the dry mass

To determine the real water content of the soil the dry mass is weighed.

Dry the soil sample in a drying oven at 105° C for 24 h.



Weigh the sample.



Enter the net mass of the dry soil sample in the HYPROP FIT software using the register "Evaluation".

# Evaluating the measurement

You can have the software HYPROP FIT evaluate the measuring data. The process runs step by step from “Information” and “Measuring” over “Evaluation” to “Fitting” and “Export”.

To get an explanation of all the software's possibilities please use the HYPROP FIT manual that you find with the following link:

[www.metergroup.com/hyprop-2/#support](http://www.metergroup.com/hyprop-2/#support)

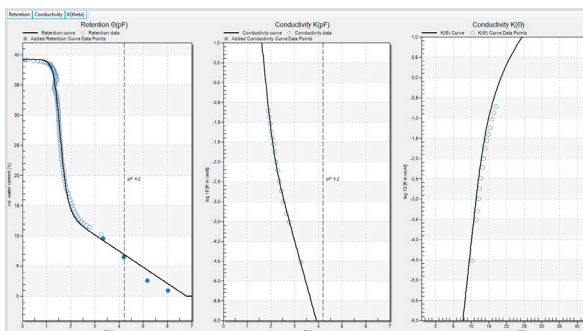

Example: Fitting of a single measurement

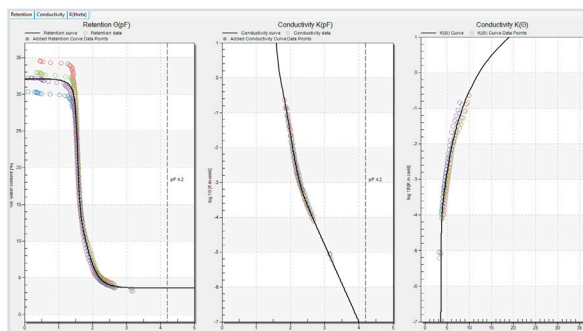

Example: Fitting of several measurements

# Trouble shooting

Problem	How to solve it
1. The tensio shaft is dry.	Fill tensio shaft either by means of a syringe or vacuum pump with deionized water (see chapter "Preparing a measurement").
2. You identify bubbles in the tensio shafts.	Repeat filling. If this does not help: try to detect leakage (e.g. red O-ring of the tensio shaft) and fix it.
3. The tension value reaches only 500 ... 700 hPa (50 ... 70 kPa) and drops then.	a) Tensio shaft has not been filled air free (how to fix it see above). b) Red O-ring of the tensio shaft does not seal properly. Check and if necessary replace O-ring (see chapter "Cleaning and maintenance").
4. The Tensio bottom stops at 200 ... 700 hPa (20 ... 70 kPa) and drops then.	Potential reasons: a) The soil sample is disrupted horizontally and was initially filled with water but later on with air which works as a capillary block. b) Same problems as #3.
5. The tension value exceeds the value of the atmospheric pressure (e.g. 1000 hPa or 100 kPa).	This is no fault but the physical effect of boiling delay. Thus you can measure with HYPROP beyond the "normal" measuring range.
6. Measuring data are no longer recorded.	a) Check connection to the USB port. b) Change energy management of your computer to "continuous operation" (typical when using a lap top).
7. At the beginning of a measurement the Tensio bottom "overtakes" the Tensio top	Maybe the tensio shafts have been interchanged. There is no need to interrupt the measurement as you can correct the measuring values in HYPROP-FIT.
8. In the "Single balance mode" the software does not find any sensor units.	Disconnect the sensor units one by one and have the software show the device tree. Probably one or more sensor units have the same address. Change addresses (see chapter "Preparing a measurement").
9. You monitor readout values of 4000 hPa (400 kPa).	The pressure sensors have been destroyed. The sensor unit must be checked. Please send it/them to METER or your local dealer. We will repair it fast and at cost-efficiently.

# Cleaning and maintenance

## Cleaning the sensor unit

The sensor unit meets the protection class IP65 and therefore can be cleaned under running water.

**Do not** remove the tensio shafts.  
Close lid of the plug.  
Clean sensor unit properly upside down under running water.  
Dry with cloth.  
When the sensor unit is clean unscrew tensio shafts by about 5 turns and clean them again. Then remove tensio shafts.



After removing the tensio shafts keep sensor unit upside down and wash residual soil particles away.



### Note

Always clean the sensor unit upside down using a wash bottle to make sure no soil particles enter the sensor unit.

# Changing the O-rings in the sensor unit

When during the tension rise the values of a tensio shaft flatten significantly or even drop before reaching the vacuum (at about 800 hPa or 80 kPa) this indicates a leakage. In this case change the red O-rings in the sensor unit.

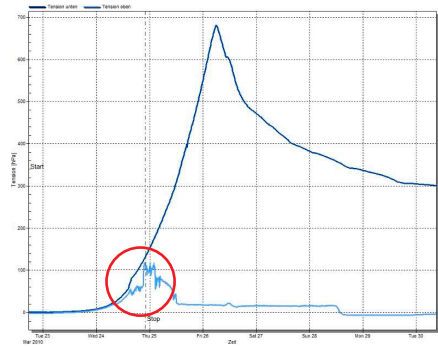

Use fine pointed tweezers to pierce the O-ring and pick it.

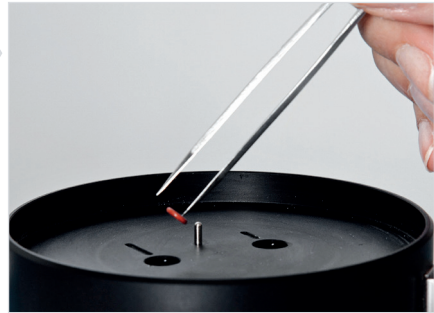

Take the spare O-ring from the service pack. Do **not** pierce it. Put O-ring into the hole and let it "snap" into the groove on the bottom. If the O-ring does not snap in itself screw in the tensio shaft cautiously.





### Note

Do not stick the tweezers tip into the hole of the sensor unit. You may damage the pressure sensor.

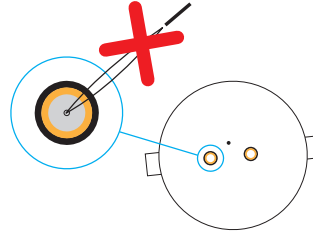

## Storage

If you do not use the HYPROP over a longer period of time make sure to avoid any algae growth.

Empty carefully sensor unit and tensio shafts.



Protect sensor unit from dust.



Store sensor unit and tensio shafts dry.

# Additional accessories

Item	Picture	Description
HYPROP® extension set Ordering no. 020 211		Consisting of sensor unit including tensio shafts and connection cable
HYPROP® BALANCE Ordering no. 020 204		USB and HYPROP® port, weighing range 2200 g, readout 0.01 g, reproducibility 0.01 g, linearity 0.01 g
HYPROP® Refill Unit 230 V ordering no. 020 257 110 V ordering no. 020 258		Complete for one HYPROP® consisting of laboratory vacuum pump (end vacuum value 8 hPa (0.8 kPa)) below the atmospheric air pressure, HYPROP® Vacuum Mount, HYPROP® Beaker Mount
HYPROP® Beaker Mount Ordering no. 020 262		Stainless steel mount, 2 beakers, 4 filling adapters
HYPROP® Vacuum Mount Ordering no. 020 268		-
HYPROP® Vacuum Pump 230 V ordering no. 020 259 110 V ordering no. 020 260		End vacuum value 8 hPa (0.8 kPa) below the atmospheric air pressure, 20 l/min, for lab use only
HYPROP® tensio shaft 50 mm ordering no. 020 277 25 mm ordering no. 020 281		Including O-rings
HYPROP® Sat Ordering no. 020 253		HYPROP® saturation plate
HYPROP® Training Ordering no. 020 254		Incl. instruction material, training hours: approx. 4
HYPROP® Adapter for 2" sample rings Ordering no. 020 150		
HYPROP® Silicone Gasket Ordering no. 020 267		

Produkt/Dienstleistung	Abbildung	
HYPROP® refilling attachment Ordering no. 020 263		For HYPROP® sensor unit, with filling valve
KSAT® Automated system for measuring the saturated hydraulic conductivity of soil samples Ordering no. 020 1		Incl. KSAT® VIEW software, 5 l storage tank, 1.2 m inlet tube, 1.2 m outlet tube, 2 gaskets for crown, trough for saturating the soil sample, stainless steel plate for testing the pressure sensor, USB port, 1 sample ring SZ 250
METER sample ring SZ250 for HYPROP®, KASAT® or BaPS 250 Ordering no. 100 201		Volume 250 ml, outside Ø 84 mm, inside 80 mm, height 50 mm, stainless steel, friction reduced polished surface for minimal soil compression, laser marked consecutive 6 digit ID number and tare with 0.1 g accuracy, incl. 2 plastic protection caps
METER hammering adapter SZA250 Ordering no. 100 201		For sample rings 250 ml with outside Ø 84 mm, stainless steel, length 300 mm, with impact protection grip
METER sample rings SZ100 Ordering no. 100 202  SZ100-2" Ordering no. 100 203		Volume 100 ml, outside Ø 60 mm, inside 56 mm, height 40.5 mm, stainless steel, friction reduced polished surface for minimal soil compression, laser marked consecutive 6 digit ID number and tare with 0.1 g accuracy, incl. 2 plastic protection caps  Like SZ100, apart from outside Ø 53 mm, inside 50 mm, height 51 mm
METER hammering adapters SZA 100 Ordering no. 100 202  SZA 100-2" Ordering no. 100 203		For sample rings 100 ml with outside Ø 60 mm, stainless steel, length 300 mm, with impact protection grip  Like SZA100 apart from outside Ø 53 mm
PE hammer Ordering no. EJ040 505		Blow-back proof, Ø 70 mm, 2.0 kg
HYPROP® tensio shaft set Ordering no. 020 255		Set with 1 x 25 mm and 1 x 50 mm tensio shaft, incl. O-rings



# Theory

## Preliminary note

HYPROP (**HY**draulic **PROP**erty analyser) is a device to measure hydraulic key functions of soil samples in a comfortable and reliable way by using an evaporation experiment.

Wind (1966) developed the evaporation method in the mid-sixties. For this 5 tensiometers were put in a soil sample. The sample was set on a balance and over the evaporation process the tensions and the mass change of the sample were measured in time intervals. Based on these data the water retention function and the unsaturated hydraulic conductivity in the range between saturation and maximum 500 hPa (50 kPa) were calculated by means of an iteration process. Schindler (1980) simplified this method. He used only 2 tensiometers and simplified the evaluation procedure. HYPROP is working based on this method. The method was tested several times and its fitness for use was proven by scientific analysis (Wendroth et al., 1993, Peters and Dumer, 2008; Peters et al., 2015). New research results yielded a further simplified measuring procedure (Schindler and Mueller, 2006) and an extended measuring range (Schindler et al., 2010a and Schindler et al., 2010b). Using the HYPROP one can today measure simultaneously the water retention curve and the unsaturated hydraulic conductivity function in the range between water saturation and close to the permanent wilting point. The measuring time amounts – depending on the soil – from 2 days (clay samples) to maximum 10 days (peat and sand samples). Additionally the dry bulk density of the sample is determined.

The measurement and evaluation can be run in two modes. In the **multi balance mode** (one balance per sample) the lab employees' work effort is limited to set up and take away the samples. In the **single balance mode** (one balance for more samples) up to 20 samples can be measured in parallel. In this mode it is necessary to put the probes manually on the balance twice a day. This takes about 15 s per sample and weighing. The measurement of the tension runs automatically. The software HYPROP-VIEW enables a comfortable data logging and storage. The software HYPROP-FIT provides the same comfort for data evaluation, fitting and export of the hydraulic key functions. The hysteresis of the saturation and dewatering characteristics of the hydraulic key functions is described in Schindler et al. (2015).

Measurements considering the shrinkage characteristics of the soil sample are described in Schindler et al., 2015. Comparing the measuring results of HYPROP and classical methods (sand box, kaolin box, pressure pot) demonstrated good congruence (Schelle et al., 2010, 2011, 2013a, b; Schindler et al., 2012). Systematical differences could not be found.

## Measuring method

HYPROP® measures the water tension/water content relation ("retention curve", "pF/WC curve") of a soil sample. It also measures how the unsaturated hydraulic conductivity depends on the water tension/content ("Ku curve"). This is based on the evaporation method according to Wind (1968) in Schindler's model (1980).

With this method two tensiometers are positioned in two depths of a soil sample sitting in a sample ring. The plane in the middle between the two tensiometers is identical with the horizontal symmetry plane of the column. The sample is saturated with water, basally closed and set on a balance. The soil surface is open to the ambient atmosphere so that the soil water can evaporate. HYPROP measures the water tension in two horizons of the soil sample over the evaporation process by means of two vertical tensio shafts (similar to T5 tensiometers). The change of the sample mass over time is determined by weighing. The medial pF value of the sample is calculated based on the average value of the two tensions. The medial water content is calculated based on the mass change. This results in one measuring value per point in time for the pF/WC curve.

The evaporation rate results from the mass differences, based on this the volume flow is calculated at each point in time. The values of the hydraulic conductivity with increasing desiccation are a result of how well the soil can transport this water to the top where it evaporates. If the conductivity is poor the soil on top dries out whereas it remains wet on the bottom. So the upper tensio shaft indicates "drier" than the lower tensio shaft which is still "wet". If the conductivity is good the whole water of the sample is evaporated and both tensio shafts indicate almost the same values. The detailed calculation basics of the method as well as the check of its validity are explained in Peters and Durner (2008) and Peters et al. (2015).

## Explanation of terms

The terms tension, matrix potential, water tension and pF value refer to the same physical value: they describe the energy that attracts water molecules – to pores capillary or to soil particles adhesively. Plants e.g. must overcome this binding energy (or attraction force), to suck water from the soil matrix.

The water is under tension in the soil. This tension or attraction force can be directly measured as a vacuum of the water compared to the atmospheric pressure. So for the measurement water in the tensio shaft is “offered” to the soil. The soil sucks it with the same force as it retains the water. As the soil has a capillary contact to the water in the tensio shaft through the pores of the ceramic the pressures of the water in the soil and in the tensio shaft finally match.

As the tensio shaft water is locked air tight, it cannot flow into the soil before the soil is so dry and accordingly the vacuum is so high that the first pore layer gets empty. This vacuum (tension) can be measured with a pressure sensor. If the vacuum is strong enough to suck the small pores empty the water entry point has been reached: air enters the tensio shaft, the pressure rises up to the atmospheric pressure and the pressure read out drops to zero.

The matrix potential is the negative value of the tension. It is often expressed in hPa or kPa. In the soil science also the pressure head is used, e.g. in the unit “cm water column”. The pF value is the decimal logarithm of a water column in cm. A soil water tension of -100 hPa is equivalent to a water column of approximately\* 100 cm. So its pF value is 2.0

The terms retention function, pF curve and pF/WC characteristics mean the same. They describe a soil characteristic dependent on the binding energy (pF value, water tension) and on the water content (WC). As an example: Sand can retain only little water, clay a lot. At or near saturation sand conducts water very well, clay however poorly. Dry sand conducts water very poorly, compared to this clay is a bit better (water conducting horizons). Please see the following retention curves for comparison.

\* as  $g = 9.81 \text{ m/s}^2$

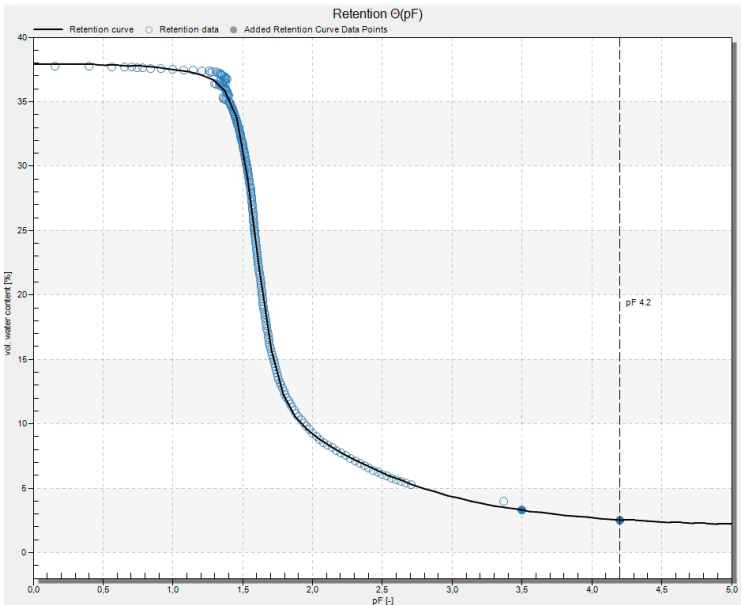

Typical retention curve of sand.

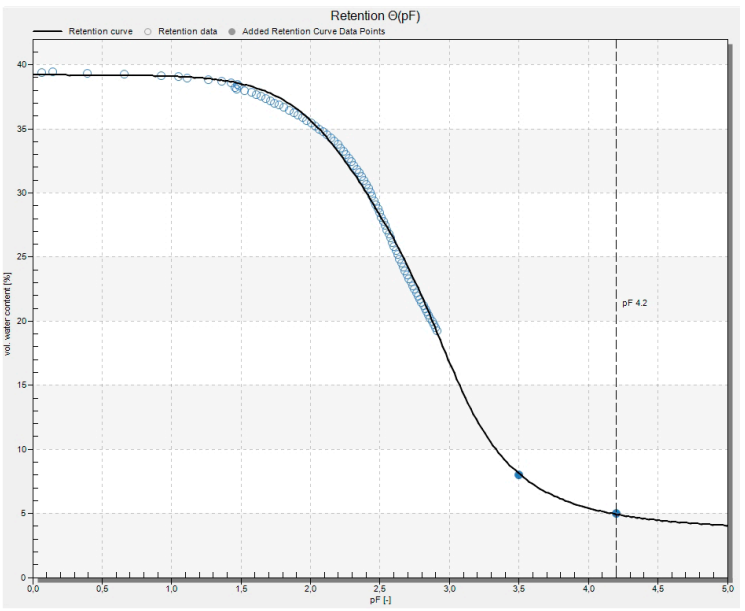

Typical retention curve of loam.

# Generating discrete data points for retention and conductivity functions

HYPROP measures the water tensions  $h_1$  and  $h_2$  (in hPa or kPa) in two measuring levels of the sample at certain points of time  $t$  being defined in the HYPROP-VIEW configuration. In the multi balance mode also the total mass of the sample is weighed (in g) at the same time. In the single balance mode the sample mass is weighed manually – usually twice a day. The software calculates the medial water content of the sample based on the sample mass minus all tare components (sensor unit, sample ring, dry mass of the soil). The dry mass of the soil can be determined after the measurement by drying the sample in an oven at 105 °C.

The measuring data are evaluated with the software HYPROP-FIT according to Schindler's method (1980). The precise calculation of the water content needs the input of the soil's dry mass. As long as the dry mass has not been entered HYPROP estimates the water content upfront. HYPROP-FIT calculates based on linearization assumptions discrete points of the retention and the conductivity curves. For this in a first step the raw data are interpolated by Hermitian splines. This has the advantage that differing measuring times of tensions and water contents can be adjusted and the number of time points that are used for calculating data are fixed a priori. The default set in HYPROP-FIT is a calculation at 100 time points that are taken from the splines.

At every calculation time point a medial water content  $\theta_i$  is calculated by dividing the mass of the soil water by the volume of the soil body. Each of these points is assigned to a tension that is calculated from the measured and averaged tensions  $h_1$  and  $h_2$ . Finally this procedure results in 100 points of the retention curve  $\theta_i(h_i)$ . In order to calculate the conductivity function it is assumed that the water flow through a horizontal plane that lies exactly in the middle of the two tensio shafts (and thus in the symmetry plane of the column) between two time points  $t_{i-1}$  and  $t_i$  is  $q_i = 1/2 (\Delta V_i / \Delta t_i) / A$ . With  $\Delta V_i$  being the water reduction (in  $\text{cm}^3$ ) over the mass change,  $\Delta t_i$  the time interval between two calculation time points and  $A$  the cross-sectional area (in  $\text{cm}^2$ ) of the column. The data points for the hydraulic conductivity function are calculated by inverting Darcy's equation:  $K_i(h_i) = -q_i / \{(\Delta h_i / \Delta z) - 1\}$ . With  $h_i$  being the time- and space-averaged tension,  $\Delta h_i$  the difference of the two tensions at the two measuring levels, and  $\Delta z$  the distance of the measuring levels (i.e. the height difference of the tensio shafts).

HYPROP-FIT filters the unreliable  $K(h)$  data pairs near saturation depending on the measuring accuracy of the tensio shafts (Peters and Durner, 2008). After this parametric functions  $\theta_i(h_i)$  and  $K_i(h_i)$  are adjusted to the measuring points  $\theta(h)$  and  $K(h)$  gained by non-linear optimization. In HYPROP-FIT the user can select the type of function; all usual models can be found (van Genuchten, 1980; Brooks and Corey, 1964; Kosugi, 1996; Fredlung-Xing, 1994) in uni- and bi-modal form as well as in a more sophisticated modelling as Peters-Durner-Iden (PDI) variant (Peters, 2013; Iden und Durner, 2014). You can find a complete description of the evaluation procedure as well as the models and the curve fitting in the HYPROP-FIT manual ([www.metergroup.com/hyprop-2/#support](http://www.metergroup.com/hyprop-2/#support)) and in Peters et al., (2015).

### Parameter optimization

The  $\theta(h)$  and  $K(h)$  functions are adapted simultaneously to the data points. This is essential as distinct parameters (i. e.  $\alpha$  and  $n$ ) at van Genuchten/Mualem) influence the shape of both functions.

The adaption is accomplished by a non-linear regression under minimization of the sum of all assessed squares of the distance between data points and model forecast. However, the assumption the water content is spread out linear over the column is not always fulfilled in coarse, pored or structured soil. Therefore, the so called "integral fit" is applied for the adaption of the retention function to avoid a systematic error (Peters and Durner, 2006). For details of the fitting procedure and data assessment please refer to Peters and Durner (2007, 2008) and Peters et al., (2015).

# Additional notes

## Influences on the measuring range

Three factors limit or extend the measuring range of the tensio shafts:

- the air entry point
- the water vapor pressure (boiling point)
- the boiling delay.

## The air entry point of the tensio shaft

This value is specific for a porous hydrophilic structure and depending on the contact angle and the pore size. The air entry point of the METER tensio shafts is about 8.8 bars so it does not limit the measuring range.

## Water vapor pressure

At a temperature of 20°C the vapour pressure of water is 2.3 kPa above vacuum. This means: If the atmospheric pressure is 100 kPa at 20°C the water will start to boil or vaporize as soon as the pressure drops below 2.3 kPa (= 97.7 kPa pressure difference). At this point the measuring range of the tensio shafts ends.

Please note that the atmospheric pressures announced by meteorological services are always related to sea level. However the true atmospheric pressure at an elevation of 500 meters above sea level is for example only 94.2 kPa (although 100 kPa are announced). In this case the measuring range at 20°C is limited to -91.9 kPa. Even if the soil gets drier and drier the tension shown by the readout will remain at this value. But as soon as the bubble point is reached a spontaneous compensation with the atmospheric pressure occurs. Then air enters the tensio shaft and the readout will rapidly drop to zero.

## Osmotic effect

The ceramic has a pore size of  $r = 0.3 \mu\text{m}$  and therefore cannot block ions. Thus, an influence of osmosis on the measurements is negligible. If the tensio shaft is dipped into a saturated NaCl solution the readout will show 1 kPa for a short moment, then it will drop to 0 kPa again.

# Addendum

## Typical measuring curves

The following typical curves were kindly provided by Prof. Dr. Wolfgang Durner.

### Sandy loam (Ls3)

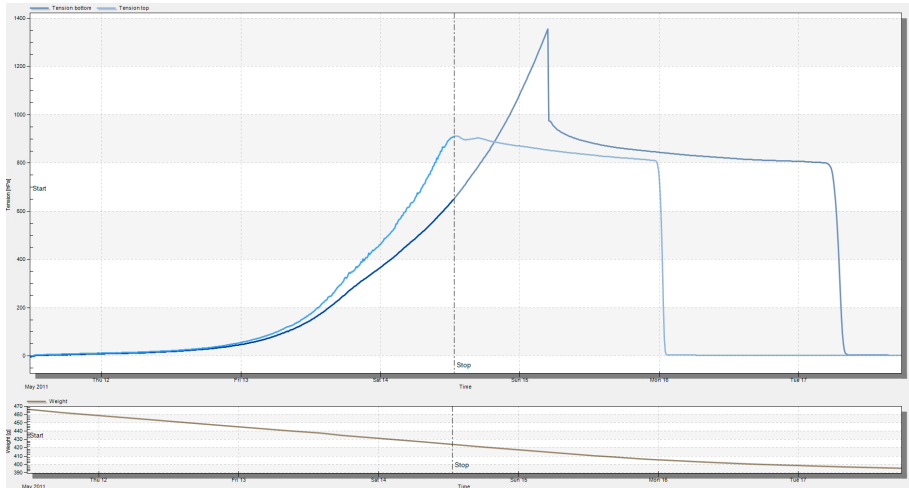

Site: Wolfenbüttel; soil type: slightly sandy loam. Ls3 (S 35%, U 48%, T 17%); measurements in winter 2011 at "Geoökologische Labormethoden 2011", TU Braunschweig. Evaporation: 2,75 mm/d, temperature: 21°C

### Description of the measuring process

- The measurement process is typical of clay with wide pore size distribution
- The water tensions rise almost two days continuously, but at a moderate slope. This reflects large pore fraction in clay of almost 10%
- From about 50 hPa (pF 1.7), the tensio shafts are far enough away to allow for the determination of hydraulic conductivities.
- After two days the tensio shafts are now moving with a greater slope, but still a rather weak curvature continues. The measurement limit is already reached a day later. This indicates a limited and simultaneously diversified porosity.
- The spreading of tension values is moderate, which indicates a relatively high hydraulic conductivity in this area.
- The measurement is completed by the (almost too early) failure of the upper tensio shaft after three days. At the time the sample is removed about 17% water.



## Evaluation

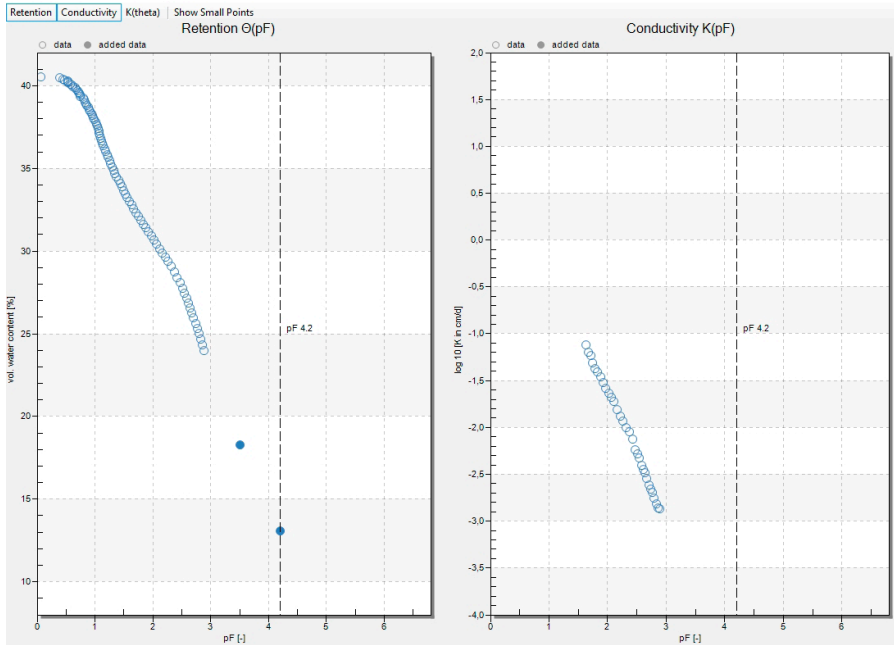

- The relatively uniform decrease in the water content with increasing pF and the drop of the relatively flat K data is characteristic of clays having a wide pore size distribution.
- The addition of the data point on the bubble point of the ceramic tip (power users only) fits very well with the independent, measured WP4 data points, and extends the range considerably.
- As a model to describe the data a bimodal function is needed.

## Clayey silt (Ut3)

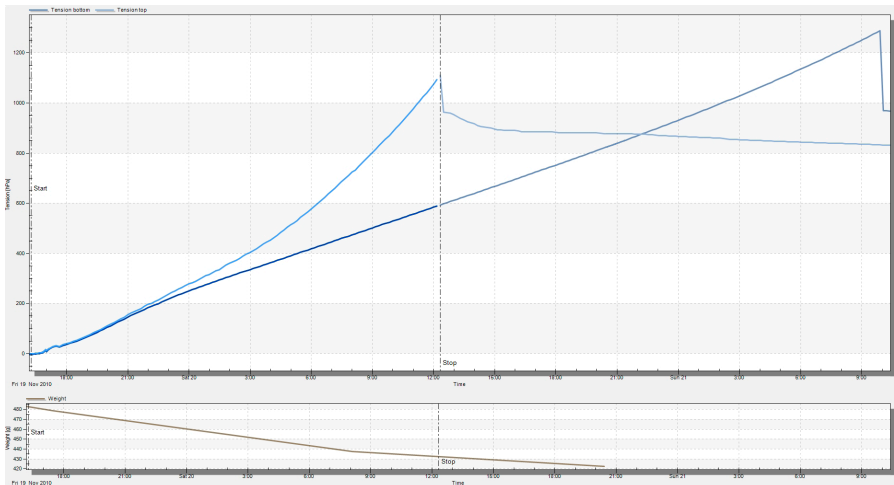

Site: Groß-Gleidingen near Braunschweig; soil type: clayey silt (S: 1%, U: 82%, T:17%); measurements: Praktikum Bodenphysik at TU Braunschweig, 2010. Evaporation: 14 mm/d using a fan. Temperature: 20°C

### Description of the measuring process

- The measurement process is typical of a very fine grained substrate.
- The water tensions rise spontaneously immediately after the start of measurement, steeply and continuously. This reflects a very small proportion of coarse pores. pF 2.0 is reached (under the given conditions with fan) after a few hours. The loss of water to pF 2 is only about 4%.
- The "spikes" at the beginning of the measurements shows the discontinuous access of air penetrating into the soil.
- From 100 hPa (pF 2.0), the first parallel tensio shafts are far enough away to allow for the determination of hydraulic conductivities.
- Both tensio shafts rise unabated with the passage of time and failed relatively soon. The clayey silt has few large middle pore, the finer middle pore region is in the time of failure still filled with water, the water content is therefore high.
- The spread of the tension values is moderate over the entire measuring process, which indicates a relatively high unsaturated conductivity.
- The measurement is completed due to the failure of the upper tensio shaft after less than one day. At this time the sample has lost about 20% water.

## Evaluation

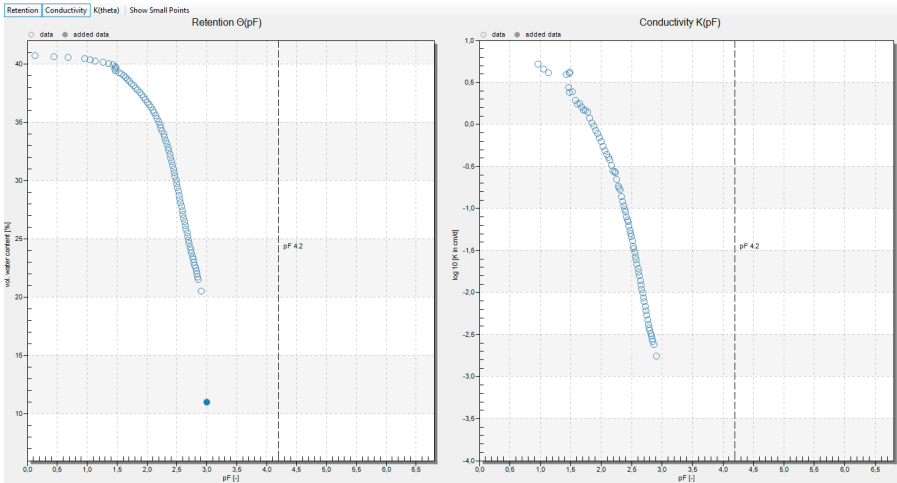

- The initially flat and then getting steeper drop down in the water content with increasing pF is characteristic of very fine grained and clay substrates.
- The hydraulic conductivity at pF 2 is very high, but the curve then is even more steep than in the case of clay.
- The description of the data with models is not a problem, however in dry areas completely unsure. Suitable models are e.g. the van Genuchten model, or Kosugi model.

## Slightly loamy Sand (S12)

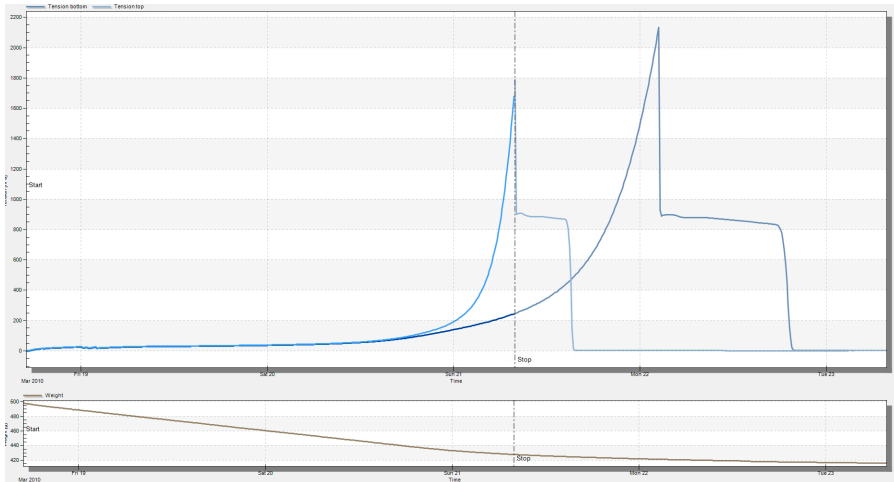

Site: METER, soil type: slightly loamy sand (S: 1%, U: 82%, T: 17%), measurements at METER Soillab, Evaporation: 5.7 mm/d, temperature: 23°C

### Description of the measuring process

- The measurement process is typical of sand with low fines
- The water tensions rise spontaneously immediately after the start of measurement, until they reach a level that corresponds to the bubble point. In this case it is about 30 cm (pF 1.5).
- Small "spikes" at the beginning of the measurements indicate that the air is not uniform but occur in the system in jerks. This will be shown in the evaluation of the retention curve.
- The tensio shafts run for a long time completely in parallel, and differ only around a hydrostatic pressure difference of 2.5 hPa .
- Only after the main pores are being drained, the upper tensio shaft value initially rises exponentially. The tensio shaft failed very quickly, and the air entry point of the ceramic tip is reached shortly, while the lower tensio shaft is still in the regular measuring range.
- The difference of the tensions is suitable only after reaching the exponential rise, that hydraulic conductivities can be calculated.
- The measurement is completed due to the failure of the upper tensio shaft after a loss of almost 30% water.

## Evaluation

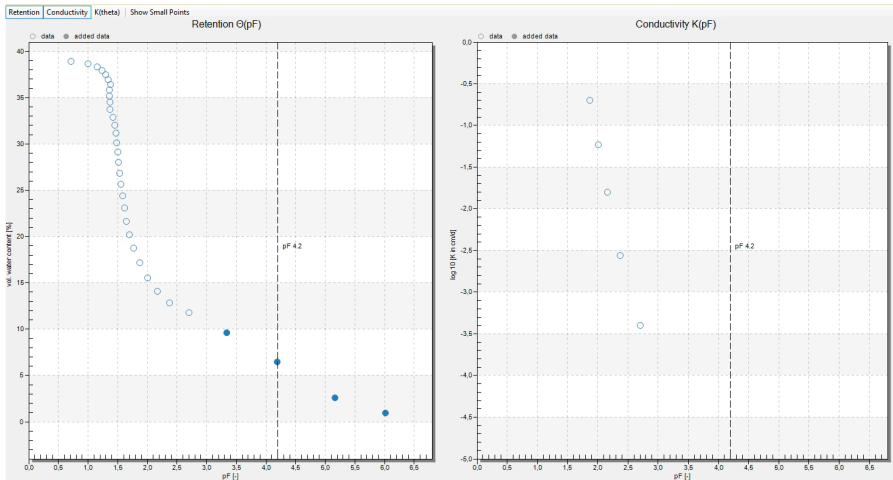

The additional data in the dry zone were measured by Lisa Heise within their thesis at TU Braunschweig /METER Munich using a device made by Decagon (WP4C). They are documented in Heise's thesis ([http://www.soil.tubs.de/mitarbeiter/dipl\\_detail.php?id=78](http://www.soil.tubs.de/mitarbeiter/dipl_detail.php?id=78)).

- The pronounced air entry point and the steep drop down of the retention curve after reaching the air entry point is characteristic of the sand.
- The hydraulic conductivity can be determined only from pF 2.0, and then drops down steeply.
- Suitable models for data description are the Fayer-Simmons model, or the bimodal model to describe the subsequent drop of the retention values towards dehydration.

## Pure fine and middle sand (Ss)

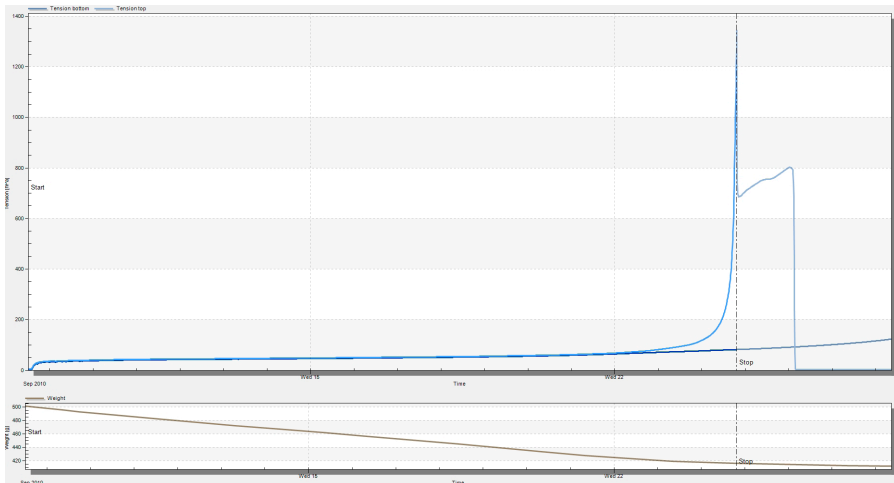

Material: packed quartz sand particle size: 0.1 bis 0.3 mm, soil type: sandy sand (S: 100%, U: 0%, T: 0%), site: Bodenphysikalisches Labor, TU Braunschweig, evaporation: 1.4 mm/d, temperature: 22°C

### Description of the measuring process

- The measurement process is typical of sand with narrow particle size distribution and without fines
- The tension rise spontaneously immediately after the start of measurement, until they reach a level that corresponds to the bubble point. In this case it is about 50 cm ( $pF$  1.7).
- The tensio shafts run for a long time completely in parallel, and differ only around a hydrostatic pressure difference of 2.5 hPa.
- After draining the main pore portion the tensio shaft value of the upper tensio shaft rises extremely steep. The failure of the tensio shaft is now very quick.
- The lower tensio shaft is at the end of the measurement still completely unaffected by the extreme dehydration front, the difference of water tensions is very high.
- Hydraulic conductivities can be calculated only for a short period of time.
- The measurement is completed due to the failure of the upper tensio shaft after removal of 35% water

## Evaluation

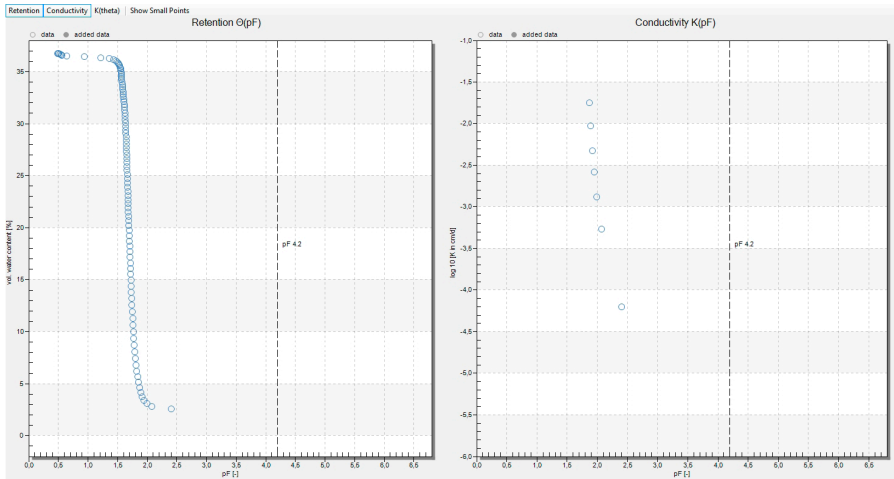

- The very sharply defined bubble point and the extremely steep drop in the retention curve after reaching the air entry point is characteristic of pure sand with a uniform grain size.
- The hydraulic conductivity can be determined only within a very narrow tension intervall, and drops down very steeply.
- Suitable models are the data description Brooks Corey model, the van Genuchten model of free parameter  $m$  or the Simmons-Fayer model.

## Standard pF curves

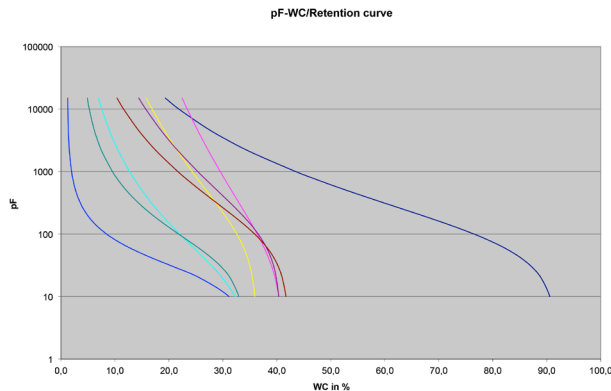

Standard pF curves  
(courtesy of Dr. Uwe Schindler,  
ZALF Muencheberg)



# Sample treatment for WP4 measurements after a HYPROP measurement

Prepare four WP4 cups as well as the related lids.

Push the soil sample – similar to a plunger – in half inch steps out of the sample ring and cut off the protruding soil piece. Let it drop into an aluminum tray.

Fill the first WP4 cup with sample material – maximum half of the cup. Close the cup immediately.

Repeat these steps for cup 2, 3 and 4. Seal the cups carefully with duck tape.

Dry the remaining soil from the tray in a drying chamber. Take it out and let it cool down in a desiccator. Weigh it.

Measure the samples in the WP4 device according to its manual.

Weigh the wet samples **immediately** after measuring in the WP4.

Put the WP4 samples into an oven and let them dry several hours at 105 °C until equilibrium is achieved. Take it out and let it cool down in a desiccator. Weigh it.



Add the dry mass of the WP4 samples to the dry mass of the remaining sample and enter this total mass in HYPROP-FIT in the register "Evaluation".

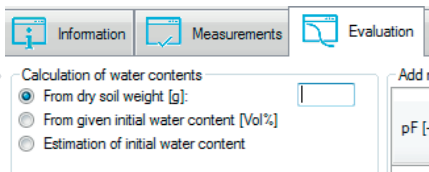

Enter the WP4 value of pF, gross wet mass (wet soil + cup), gross dry mass (dry soil + cup) and tare mass (cup only) in the register "Evaluation" and the table "Add WP4 data points". This can be done by cut and paste from a spreadsheet.

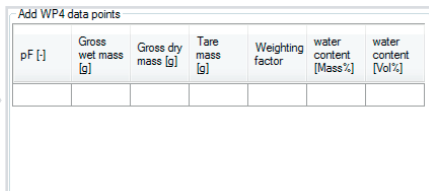

The gravimetric water contents are calculated automatically, converted into volumetric water contents, and added to the graphics. When fitting the hydraulic properties these data have the same weighing factor as the HYPROP data. Power user may change this factor.

## Units for soil water and matrix potentials

	pF	hPa	kPa=J/kg	MPa	bar	psi	%F
	1	-10	-1	-0.001	-0.01	-0.15	99.9993
FC field capacity	1.8	-62	-6.2	-0.006	-0.06	-0.89	99.998
	2	-100	-10	-0.01	-0.1	-1.45	99.9926
Standard measuring range of tensiometers	2.9	ca. 850	-85	-0.085	-0.85	-12.3	
	3	-1,000	-100	-0.1	-1	-14.5	99.9261
	4	-10,000	-1,000	-1.0	-10	-145.0	99.2638
Permanent wilting point	4.2	-15,000	-1,500	-1.5	-15	-219.5	98.8977
	5	-100,000	-10,000	-10	-100	-1450.4	92.8772
Air dry, depending on air humidity	6	-1,000,000	-100,000	-100	-1,000	-1450.4	47.7632
Oven-dry	7	-10,000,000	-1,000,000	-1,000	-10,000	-1450.38	0.0618

Note: 0.981 kPa corresponds to 10 cm water column

# Facts and figures

## Technical data

<b>Sensor unit</b> Material Dimensions	Fiber glass reinforced Polyamide Height 60 mm, Ø 80 mm
<b>Tensio shafts</b> Ceramic Shaft material Total length	Al <sub>2</sub> O <sub>3</sub> sinter, bubble point > 200 kPa; Ø 5 mm Acrylic glass; Ø 5 mm Small tensio shaft: 31 mm Big tensio shaft: 56 mm
<b>Measuring range</b> Pressure transducer Temperature	-3.0 ... 3000 hPa (-0.3 ... 300 kPa), electronic -30 ... 70 °C
<b>Accuracy</b> Pressure Temperature	± 2,5 hPa / d = 0,05 hPa (+100 ... -500 hPa) ± 0,2 K (at -10 ... 30 °C) / d = 0,01 K
<b>Power supply</b> Voltage Current	6 ... 10 V DC 6 mA nominal, 15 mA max.
<b>Chemical resistance</b> pH range	pH3 ... pH10, Limited to media that do not affect silicon, fluorosilicone, EPDM, PMMA or polyetherimide
<b>Protection</b> Housing with covered plug	IP65 splash water proof
<b>Sensor units</b> Number of sensor units supported by tensioLINK	20
<b>HYPROP balance</b> Connection to computer Weighing range Readout Reproducibility Linearity Adjustment	USB 2200 g 0,01 g 0,01 g 0,01 g internally

# Literature cited

## Note

If you want to cite this manual please use the following information: UMS (2015): Manual HYPROP, Version 2015-01, 96 pp. UMS GmbH, Gmunder Straße 37, Munich, Germany. URL [www.metergroup.com/hyprop-2/#support](http://www.metergroup.com/hyprop-2/#support)

- **Brooks, R. H. and Corey, A. T.** (1964): Hydraulic properties of porous media. Hydrology Paper 3. Colorado State University, Fort Collins, Colorado.
- **Fredlund, D. G., & Xing, A.** (1994): Equations for the soil-water characteristic curve. Canadian geotechnical journal, 31(4), 521-532.
- **Iden, S.C., and W. Durner** (2014): Comment to "Simple consistent models for water retention and hydraulic conductivity in the complete moisture range" by A. Peters., Water Resour. Res., 50, 7530–7534.
- **Kosugi, K. I.** (1996): Lognormal distribution model for unsaturated soil hydraulic properties. Water Resources Research, 32(9), 2697-2703.
- **Peters, A. and Durner, W.** (2006): Improved estimation of soil water retention characteristics from hydrostatic column experiments. Water Resources Research 42 (11).
- **Peters, A. and Durner, W.** (2008): Simplified Evaporation Method for Determining Soil Hydraulic Properties. Journal of Hydrology 356 (1-2): 147– 162.
- **Peters, A. and Durner, W.** (2007): Optimierung eines einfachen Verdunstungsverfahrens zur Bestimmung bodenhydraulischer Eigenschaften. Mitteilungen der Deutschen Bodenkundlichen Gesellschaft 110 (1): 125-126.
- **Peters, A.** (2013): Simple consistent models for water retention and hydraulic conductivity in the complete moisture range, Water Resour..Res., 49, 6765–6780.
- **Peters, A., S.C. Iden, and W. Durner** (2015): Revisiting the simplified evaporation method: Identification of hydraulic functions considering vapor, film and corner flow. Journal of Hydrology, in press.

- **Schelle, H., Iden, S. C., Peters, A. and Durner, W.** (2010): Analysis of the agreement of soil hydraulic properties obtained from multistep-outflow and evaporation methods. *Vadose Zone Journal* 9 (4): 1080-1091.
- **Schelle, H., Iden, S. C. and Durner, W.** (2011): Combined transient method for determining soil hydraulic properties in a wide pressure head range. *Soil Science Society of America Journal* 75 (5): 1-13.
- **Schelle, H., Heise, L., Jänicke, K. and Durner, W.** (2013a): Wasserretentionseigenschaften von Böden über den gesamten Feuchtebereich - ein Methodenvergleich. - In: Beiträge zur 15. Lysimetertagung am 16. and 17. April 2013, HBFLA Raumberg-Gumpenstein.
- **Schelle, H., Heise, L., Jänicke, K. and Durner, W.** (2013b): Water retention characteristics of soils over the whole moisture range: a comparison of laboratory methods. *European Journal of Soil Science* 64 (6): 814-821.
- **Schindler, U.** (1980): Ein Schnellverfahren zur Messung der Wasserleitfähigkeit im teilgesättigten Boden an Stechzylinderproben. *Archiv für Acker- und Pflanzenbau und Bodenkunde* 24 (1): 1-7.
- **Schindler, U. and Müller, L.** (2006): Simplifying the evaporation method for quantifying soil hydraulic properties. *Journal of Plant Nutrition and Soil Science* 169 (5): 623-629.
- **Schindler, U., Durner, W., von Unold, G. and Müller, L.** (2010a): Evaporation method for measuring unsaturated hydraulic properties of soils: Extending the measurement range. *Soil Science Society of America Journal* 74 (4): 1071-1083.
- **Schindler, U., Durner, W., von Unold, G., Müller, L. and Wieland, R.** (2010b): The evaporation method: Extending the measurement range of soil hydraulic properties using the air entry pressure of the ceramic cup. *Journal of Plant Nutrition and Soil Science* 173 (4): 563-572.
- **Schindler, U., Doerner, J. and Müller, L.** (2015): Simplified method for quantifying the hydraulic properties of shrinking soils. *Journal of Plant Nutrition and Soil Science* 178 (1): 136-145.
- **METER** (2015): HYPROP-Fit User Manual. METER Group AG Mett-lacher Straße 8, 81379 München, Germany, 2015. URL [www.meter-group.com/hyprop-2/#support](http://www.meter-group.com/hyprop-2/#support)

- **Van Genuchten, M. T.** (1980): A closed-form equation for predicting the hydraulic conductivity of unsaturated soils. *Soil Science Society of America Journal* 44: 892-898.
- **Wind, G.P.** (1968): Capillary conductivity data estimated by a simple method. p.181–191. In R.E. Rijtema and H. Wassink (ed.) *Water in the Unsaturated Zone: Proc. UNESCO/IASH Symp., Wageningen, the Netherlands.*

© 2018 METER Group AG

HYPROP User Manual v 2018/3

Subject to modifications and amendments without notice.

HYPROP® is a registered trademark of METER Group AG.

**METER Group AG**

Mettlacher Straße 8

81379 Munich

Phone +49 (0) 89 / 12 66 52 - 0

Fax +49 (0) 89 / 12 66 52 - 20

[environment@metergroup.de](mailto:environment@metergroup.de)

[www.metergroup.com](http://www.metergroup.com)