



METER

# TEROS 06



# TABLE OF CONTENTS

<b>1. Introduction</b>	<b>1</b>
<b>2. Operation</b>	<b>2</b>
2.1 Installation	2
2.2 Drilling With the TEROS 06 Auger	4
2.3 Connecting	4
2.3.1 Connect to METER Data Logger	5
2.3.2 Connect to a Non-METER Data Logger	6
2.4 Communication	8
2.5 Removing the Sensor	9
<b>3. System</b>	<b>10</b>
3.1 Specifications	10
3.2 Components	13
<b>4. Service</b>	<b>14</b>
4.1 Calibration	14
4.2 Maintenance	14
4.3 Troubleshooting	14
4.4 Customer Support	15
4.5 Terms and Conditions	15
<b>Index</b>	<b>16</b>

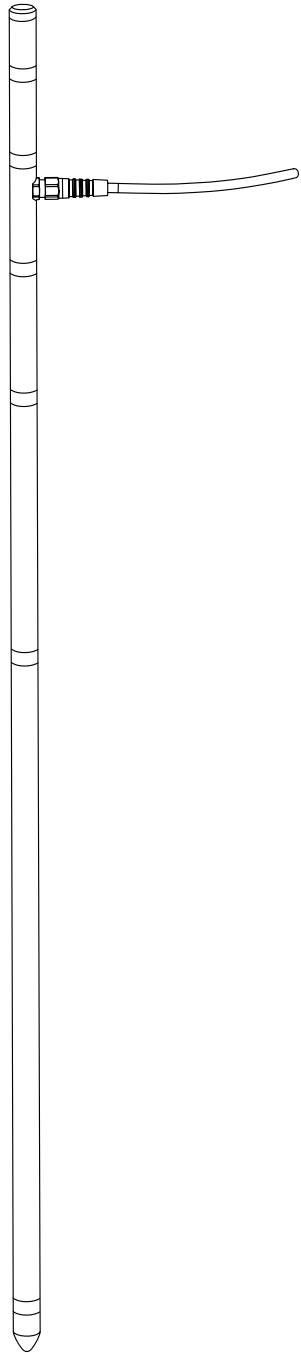

# 1. INTRODUCTION

Thank you for choosing the TEROS 06 temperature profile probe from METER Group.

TEROS 06 measures soil temperature at specified depths following World Meteorological Organization (WMO) recommendations.

TEROS 06 is designed for measurements in the field, in lysimeters, and in water bodies. The small diameter of 20 mm minimizes soil disturbance and the fiberglass reinforced plastic body causes no temperature carryover between profile layers.

## 2. OPERATION

Please read all instructions in this section before operating the TEROS 06 to ensure it performs to its full potential.

### PRECAUTIONS

METER sensors are built to the highest standards, but misuse, improper protection, or improper installation may damage the sensor and possibly void the manufacturer's warranty. Before integrating TEROS 06 into a system, make sure to follow the recommended installation instructions and have the proper protections in place to safeguard sensors from damage. If installing sensors in a lightning-prone area with a grounded data logger, see the application note [Lightning surge and grounding practices](#).

## 2.1 INSTALLATION

When selecting a site for installation, remember the soil adjacent to the sensor surface has the strongest influence on the sensor reading.

Follow the steps listed in [Table 1](#) to set up the TEROS 06 and start collecting data.

**Table 1 Installation**

Tools Needed	<p><b>TEROS 06 auger</b></p> <p><b>Dead blow hammer</b></p> <p><b>PVC casing or flexible conduit</b> (to protect cables)</p> <p><b>Cable inserting tool</b> (if using long flexible conduits)</p> <p><b>Spade</b> (to dig a slot for the cable)</p> <p><b>Level</b> (to check that auger is level as it is digging the hole for sensor)</p>
Preparation	<p><b>Conduct System Check</b></p> <p>Plug the sensor into the logger (<a href="#">Section 2.3</a>) to make sure the sensor is functional.</p>
Installation	<p><b>Create Hole</b></p> <p>Avoid interfering objects, such as roots or rocks.</p> <p>Mark the required drilling depth (104 cm) on the TEROS 06 auger.</p> <p>Drill a hole stepwise until the marker reaches the soil surface (<a href="#">Section 2.3</a>). Avoid soil compaction by drilling with several steps (maximum drilling step length = 30 cm).</p> <p><b>ATTENTION: Minimize air gaps and soil compaction around the sensor. Air gaps around the sensor will result in slow readings of soil temperature.</b></p> <p>Dig a narrow trench 15 cm deep with a spade from the TEROS 06 installation location to the data logger site to bury the sensor cable.</p>

Table 1 Installation (continued)

**NOTE:** Burying the sensor cable will prevent thermal heat flux through the sensor cable into the TEROS 06. Otherwise solar radiation may heat up the cable and may affect reported temperature values.

#### Insert Sensor

Gently insert the probe into the borehole until the shaft end is flush with the soil surface.

If the borehole is too tight, remove the sensor and insert the auger. Rotate the auger one or two revolutions to expand the borehole a bit.

**DO NOT** use a hammer to drive in the sensor!

#### Secure and Protect Cables

**NOTE:** Improperly protected cables can lead to severed cables or disconnected sensors. Cabling issues can be caused by many factors such as rodent damage, driving over sensor cables, tripping over cables, not leaving enough cable slack during installation, or poor sensor wiring connections.

Install cables in conduit or plastic cladding when near the ground to avoid rodent damage.

Lay the cables in the trench.

Gather and secure cables between the TEROS 06 and the data logger to the mounting mast in one or more places.

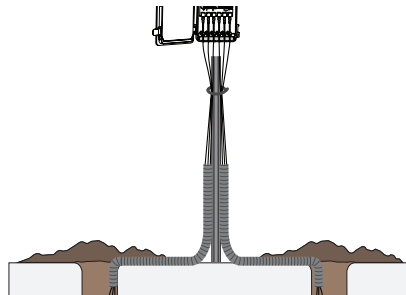

#### Connect to Logger

Plug the sensor into a data logger.

Use the data logger to make sure the sensor is reading properly.

Verify that these readings are within expected ranges.

For more specific instructions on connecting to data loggers, refer to [Section 2.3](#).

**NOTE:** Electrical installations must comply with the safety and EMC requirements of the country in which the system is to be used.

#### Backfill the Soil

Return soil to the hole and trench in the order it was removed. Pack the soil back to its native bulk density.

## 2.2 DRILLING WITH THE TEROS 06 AUGER

METER recommends using only the specially designed TEROS 06 auger ([Figure 1](#)) for installing the TEROS 06. The auger creates a tight borehole for the sensor to maintain good thermal contact with the soil.

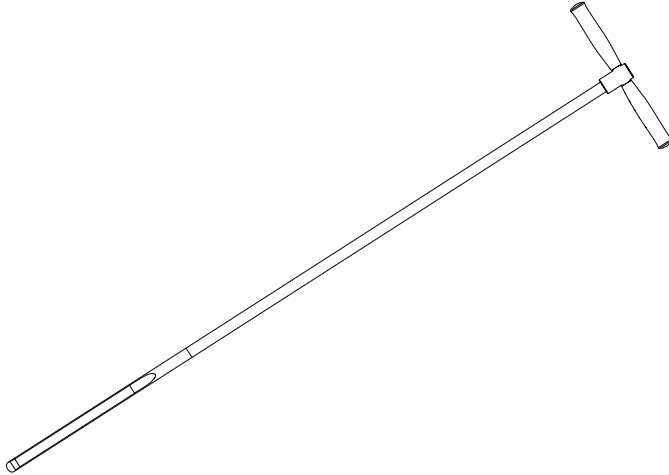

Figure 1 TEROS 06 auger

The following steps detail how to use the TEROS 06 auger:

1. Assemble the auger using the handle and auger head.
2. Mark the sensor length (104 cm) on the auger head.
3. Place the auger tip on the ground and adjust to vertical using a level.
4. Hit the handle gently a few times with a dead blow hammer until the auger head is 30 cm in the ground.

Continue to check the level for a proper upright angle until the auger is in far enough that the angle does not change.

5. Rotate the auger one revolution clockwise to cut off the soil in the borehole.
6. Pull the auger out of the borehole after every 30-cm increment to avoid soil compaction.
7. Remove the soil inside the auger head.
8. Repeat [step 4](#) through [step 7](#) until desired depth is reached.

## 2.3 CONNECTING

The TEROS 06 works seamlessly with METER data loggers. The TEROS 06 can also be used with other data loggers, such as those from Campbell Scientific, Inc. For extensive directions on how to integrate the sensors into third-party loggers, refer to the [TEROS 06 Integrator Guide](#).

TEROS 06 sensors require an excitation voltage in the range of 3.9 to 28.0 VDC and operate at a 3.3-VDC level for data communication. TEROS 06 can be integrated using DDI serial, SDI-12 protocol, Modbus RTU protocol, or tensioLINK protocol. See the [TEROS 06 Integrator Guide](#) for details on interfacing with data acquisition systems.

TEROS 06 sensors come with either a 3.5-mm stereo plug connector ([Figure 2](#)) to facilitate easy connection with METER loggers or with a 4-pin M12 connector ([Figure 3](#)) to facilitate connecting to some third-party loggers ([Section 2.3.2](#)).

The TEROS 06 comes standard with a 4.5-m cable. In some instances, the cable can be extended beyond 75 m by the user, but this is discouraged for a variety of reasons. Please contact [Customer Support](#) for more details before extending or splicing cables.

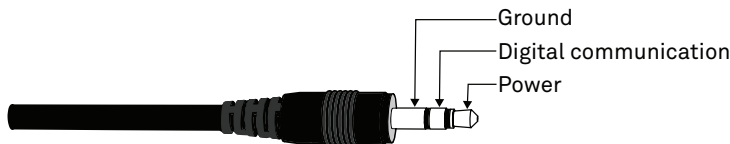

Figure 2 3.5-mm stereo plug connector wiring used with METER loggers

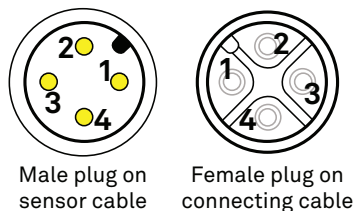

Figure 3 4-pin M12 plug connector used with non-METER loggers

### 2.3.1 CONNECT TO METER DATA LOGGER

The TEROS 06 works most efficiently with METER ZENTRA series data loggers. Check the METER download webpage ([metergroup.com/downloads](http://metergroup.com/downloads)) for the most recent data logger firmware. Logger configuration may be done using either ZENTRA Utility (desktop and mobile application) or ZENTRA Cloud (web-based application for cell-enabled data loggers).

METER recommends using a standard stereo plug connector with a METER ZENTRA series data logger using SDI-12 communications protocol.

1. Plug the 3.5-mm stereo plug connector into one of the sensor ports on the logger.
2. Use the appropriate software application to configure the chosen logger port for the TEROS 06. METER data loggers will automatically recognize TEROS 06 sensors.
3. Set the measurement interval.

METER data loggers measure the TEROS 06 every minute and return the average of the 1-min data across the chosen measurement interval.



TEROS 06 data can be downloaded from METER data loggers using either ZENTRA Utility or ZENTRA Cloud. Refer to the logger user manual for more information about these programs.

### 2.3.2 CONNECT TO A NON-METER DATA LOGGER

The TEROS 06 can be used with non-METER (third party) data loggers. Refer to the third-party logger manual for details on logger communications, power supply, and ground ports. The [TEROS 06 Integrator Guide](#) also provides detailed instructions on connecting sensors to non-METER loggers.

METER recommends using a 4-pin M12 plug connector and a connection cable with open wires for use with a non-METER data logger using either SDI-12, tensioLINK serial, or Modbus RTU communications protocol.

If the TEROS 06 cable being used with a non-METER data logger has a standard stereo plug connector and needs to be connected to a non-METER data logger, use one of the following two options.

#### Option 1

1. Clip off the stereo plug connector on the sensor cable.
2. Strip and tin the wires.
3. Wire it directly into the data logger.

This option has the advantage of creating a direct connection with no chance of the sensor becoming unplugged. However, it then cannot be easily used in the future with a METER readout unit or data logger.

#### Option 2

Obtain an adapter cable from METER.

The adapter cable has a connector for the stereo plug connector on one end and three wires (or pigtail adapter) for connection to a data logger on the other end. The stripped and tinned adapter cable wires have the same termination as in [Figure 4](#): the brown wire is excitation, the orange is output, and the bare wire is ground.

**NOTE:** Secure the stereo plug connector to the pigtail adapter connections using adhesive-lined heat shrink to ensure the sensor does not become disconnected during use.

Connect the TEROS 06 wires to the data logger as illustrated in [Figure 4](#) and [Figure 5](#), with the power supply wire (brown) connected to the excitation, the out wire (orange) to a digital input, and the bare ground wire to ground. Refer to the third-party logger manual for details on wiring. Secure the stereo plug connector to the pigtail adapter connections to ensure the sensor does not become disconnected during use.

# TEROS 06

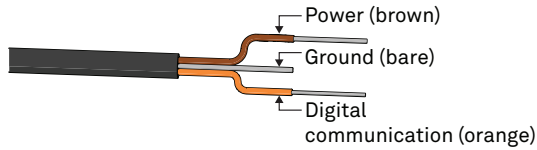

Figure 4 Pigtail wiring

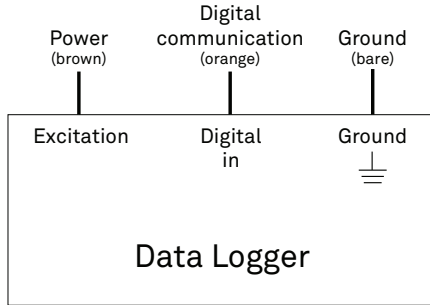

Figure 5 Wiring diagram

**NOTE:** The acceptable range of excitation voltages is from 3.9 to 28.0 VDC. To read the TEROS 06 with Campbell Scientific data loggers, power the sensors off a 12-V port or switched 12-V port.

If the TEROS 06 has the M12 plug connecting cables, connect the TEROS 06 wires to the data logger as illustrated in Figure 6 and either Figure 7 or Figure 8, depending on the desired protocol. Connect the screen (thick black wire) to grounding.

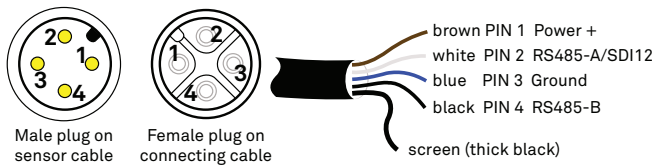

Figure 6 4-pin M12 plug wiring

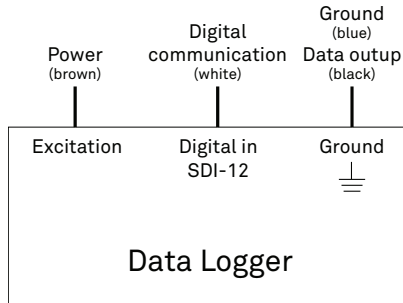

Figure 7 Wiring diagram for M12 plug and SDI-12 communication

## OPERATION

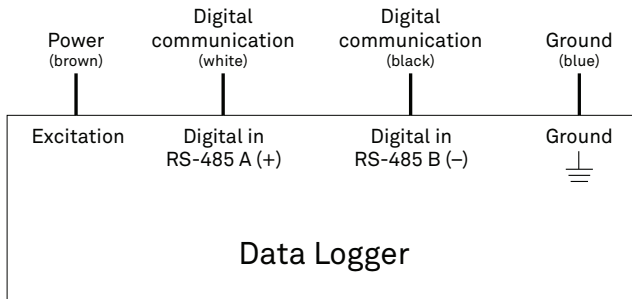

Figure 8 Wiring diagram for M12 plug and RS-485 communication

## 2.4 COMMUNICATION

The TEROS 06 sensor communicates using different methods:

- DDI serial communications protocol
- SDI-12 communications protocol
- RS-485 tensioLINK communications protocol (M12 plug only)
- RS-485 Modbus RTU communications protocol (M12 plug only)

To obtain detailed instructions for using these protocols, read the [TEROS 06 Integrator Guide](#).

The SDI-12 protocol requires that all sensors have a unique address. If the TEROS 06 is being used with a non-METER logger using SDI-12 protocol on a bus, use the METER ZSC and the METER ZENTRA Utility Mobile app to change the sensor SDI-12 address. See the individual sensor integrator guide for more information about the SDI-12 protocol in the sensors.

**NOTE:** The sensor SDI-12 address must be returned to 0 to work with ZENTRA loggers.

1. Using a mobile device, open the ZENTRA Utility Mobile app.
2. Connect the sensor to the ZSC.
3. Under Sensor Information, select the SDI Address dropdown.
4. Scroll through the options and select the desired SDI-12 address.

**NOTE:** Address options include 0-9, A-Z, and a-z.

Detailed information can also be found in the application note [Setting SDI-12 addresses on METER digital sensors using Campbell Scientific data loggers and LoggerNet](#) ([metergroup.com/address-csi-loggers](http://metergroup.com/address-csi-loggers)).

When using the sensor as part of an SDI-12 bus, excite the sensors continuously to avoid issues with initial sensor startup interfering with the SDI-12 communications.

## 2.5 REMOVING THE SENSOR

To remove the sensor from the soil, pull gently on the sensor shaft until the sensor is out of the soil.

**WARNING:** Do not pull by the cable! Doing so may break internal connections and make the sensor unusable.

## 3. SYSTEM

This section describes the specifications, components, and theory of the TEROS 06.

### 3.1 SPECIFICATIONS

#### MEASUREMENT SPECIFICATIONS

##### Temperature

Range	-20 to +50 °C
Resolution	±0.03 °C
Accuracy	±0.1 °C (0 to 30 °C) ±0.2 °C (-20 to 50 °C)

##### Measurement Depths

5 cm, 10 cm, 20 cm, 30 cm, 50 cm, 100 cm

#### COMMUNICATION SPECIFICATIONS

##### Output

- SDI-12 one-wire serial interface
  - DDI serial communications protocol
  - SDI-12 communications protocol
- RS-485 two-wire serial interface (M12 connector only)
  - tensioLINK serial communications protocol
  - Modbus RTU communications protocol

##### Data Logger Compatibility

METER ZL6 data loggers and any data acquisition system capable of 3.9- to 28.0-VDC power and serial interface with SDI-12 and/or RS-485 interface, Modbus RTU, or tensioLINK communication

#### PHYSICAL SPECIFICATIONS

##### Dimensions

Length	104.0 cm (40.94 in)
Diameter	2.0 cm (0.79 in)

##### Operating Temperature Range

Minimum	-30 °C
Maximum	60 °C

**Materials**

Shaft	PA66GF30
Sensor elements	Stainless steel

**Cable Length**

4.5 m (standard)
75 m (maximum custom cable length using M12 connector and elongation cables)

**Connector Types**

3.5-mm stereo plug connector
4-pin M12 plug connector

**NOTE:** If a stripped and tinned wire is needed, please contact [Customer Support](#).

**ELECTRICAL AND TIMING CHARACTERISTICS****Supply Voltage (VCC to GND)**

Minimum	3.9 VDC continuous
Typical	
Maximum	28.0 VDC continuous

**Digital Input Voltage (Logic High)**

Minimum	1.9 V
Typical	3.6 V
Maximum	5.0 V

**Digital Input Voltage (Logic Low)**

Minimum	-0.3 V
Typical	0.0 V
Maximum	1.0 V

**Digital Output Voltage (Logic High)**

Minimum	NA
Typical	3.6 V
Maximum	NA

**Power Line Slew Rate**

Minimum	1.0 V/ms
Typical	NA
Maximum	NA

**Current Drain (During Measurement)**

Minimum	2.0 mA
Typical	2.5 mA
Maximum	4.0 mA

**Current Drain (While Asleep)**

Minimum	NA
Typical	80.0 $\mu$ A
Maximum	NA

**Power Up Time (DDI Serial Ready)**

Minimum	210 ms
Typical	NA
Maximum	400 ms

**Power Up Time (SDI-12 Ready, DDI Disabled)**

Minimum	210 ms
Typical	NA
Maximum	400 ms

**Power Up Time (RS-485 Ready, DDI Disabled)**

Minimum	210 ms
Typical	NA
Maximum	400 ms

**Measurement Duration**

Minimum	30 ms
Typical	NA
Maximum	240 ms

## COMPLIANCE

Manufactured under ISO 9001:2015

EM ISO/IEC 17050:2010 (CE Mark)

## 3.2 COMPONENTS

The TEROS 06 measures soil temperature in six defined depths of 5 cm, 10 cm, 20 cm, 30 cm, 50 cm, and 100 cm. At every measuring depth, the sensor rod is equipped with a 1-cm high stainless steel ring, and the digital sensor is mounted at the inner surface of the stainless steel ring. The stainless steel rings have thermal contact to the soil and they transmit the soil temperature directly to the temperature sensor. To prevent thermal transfer through the cable, the cable inlet is placed 14 cm below the soil surface to protect the sensor cable from solar radiation (Figure 9).

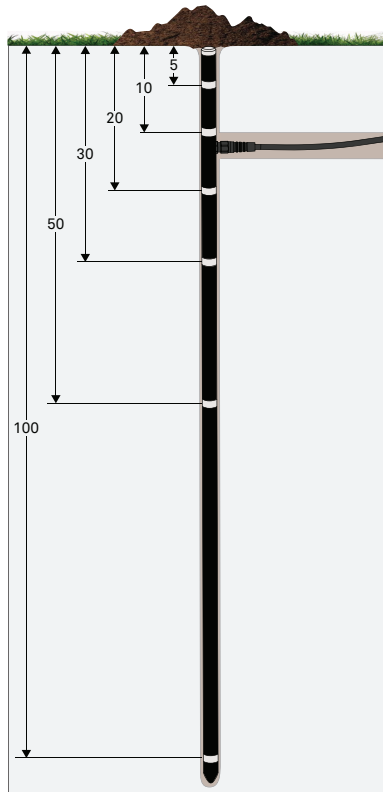

Figure 9 Temperature profile probe TEROS 06



## 4. SERVICE

This section describes the calibration, maintenance, troubleshooting guidelines, customer support contact information, and terms and conditions.

### 4.1 CALIBRATION

Every TEROS 06 sensor is individually calibrated in a water quench at a temperature of 10 °C. No calibration is needed by the customer. The TEROS 06 sensor output temperature is in degrees Celsius unless otherwise stated in the data logger program, such as in the preferences in ZENTRA software.

### 4.2 MAINTENANCE

TEROS 06 may be returned to METER for maintenance in the following areas: system inspection, recalibration, and instrument cleaning. Contact [Customer Support](#) for more information.

### 4.3 TROUBLESHOOTING

[Table 2](#) lists common problems and their solutions. If the problem is not listed or these solutions do not solve the issue, contact [Customer Support](#).

**Table 2 Troubleshooting the TEROS 06**

Problem	Possible Solutions
<b>Data logger is not recognizing sensor</b>	<p>If using a METER logger, update logger firmware.</p> <p>Check the logger configuration for a non-METER data logger using its user manual.</p>
<b>Data logger is not receiving readings from the sensor</b>	<p>Check that the connections to the data logger are both correct and secure.</p> <p>Ensure that the data logger batteries are not dead or weakened.</p> <p>Check the configuration of the data logger through software to ensure TEROS 06 is selected.</p> <p>Ensure the software and firmware is up to date.</p>
<b>Sensor is not responding</b>	<p>Check power to the sensor.</p> <p>Check the sensor cable and connector integrity.</p> <p>Check that the data logger wiring is correct (<a href="#">Section 2.3</a>).</p>
<b>Cable or connector failure</b>	<p>If a stereo plug or M12 connector is damaged or needs to be replaced, contact <a href="#">Customer Support</a> for a replacement connector and splice kit.</p> <p>If a cable is damaged, follow the guidelines in <a href="#">Section 2.3.2</a> for wire splicing and sealing techniques.</p>

## 4.4 CUSTOMER SUPPORT

### NORTH AMERICA

Customer service representatives are available for questions, problems, or feedback Monday through Friday, 7:00 am to 5:00 pm Pacific time.

**Email:** [support.environment@metergroup.com](mailto:support.environment@metergroup.com)  
[sales.environment@metergroup.com](mailto:sales.environment@metergroup.com)

**Phone:** +1.509.332.5600

**Fax:** +1.509.332.5158

**Website:** [metergroup.com](http://metergroup.com)

### EUROPE

Customer service representatives are available for questions, problems, or feedback Monday through Friday, 8:00 to 17:00 Central European time.

**Email:** [support.europe@metergroup.com](mailto:support.europe@metergroup.com)  
[sales.europe@metergroup.com](mailto:sales.europe@metergroup.com)

**Phone:** +49 89 12 66 52 0

**Fax:** +49 89 12 66 52 20

**Website:** [metergroup.de](http://metergroup.de)

If contacting METER by email, please include the following information:

Name	Email address
Address	Instrument serial number
Phone	Description of the problem

**NOTE:** For products purchased through a distributor, please contact the distributor directly for assistance.

## 4.5 TERMS AND CONDITIONS

By using METER instruments and documentation, you agree to abide by the METER Group, Inc. USA Terms and Conditions. Please refer to [metergroup.com/terms-conditions](http://metergroup.com/terms-conditions) for details.

# INDEX

## A

accuracy 10

## C

cable length 11

calibration and configuration

    sensor calibration scheduler 14

compliance 13

connecting

    METER data logger 5

    non-METER logger 6–7

connecting the TEROS 06 4

connector types 11

customer support 15

## D

data acquisition system.

*See* installation, connecting the TEROS 06

## E

email address 15

## F

fax number 15

## I

installation 2

    connecting the TEROS 06 4–6

    mounting 3

    tools required 2

## M

measurements 10–12

measurement specifications.

*See* specifications, measurement specifications

## P

phone number 15

## R

range 10

## S

specifications 10–13

    communication 10

    data logger compatibility 10

    measurement specifications 10

    physical 10

## T

terms and conditions 15

## W

wiring 7–8

**METER Group, Inc. USA**

2365 NE Hopkins Court Pullman, WA 99163  
T: +1.509.332.2756 F: +1.509.332.5158  
E: info@metergroup.com W: metergroup.com

**METER Group AG**

Mettlacher Straße 8, 81379 München  
T: +49 89 1266520 F: +49 89 12665220  
E: info.europe@metergroup.com W: metergroup.de

